

KLASIK C CLEAR 2017

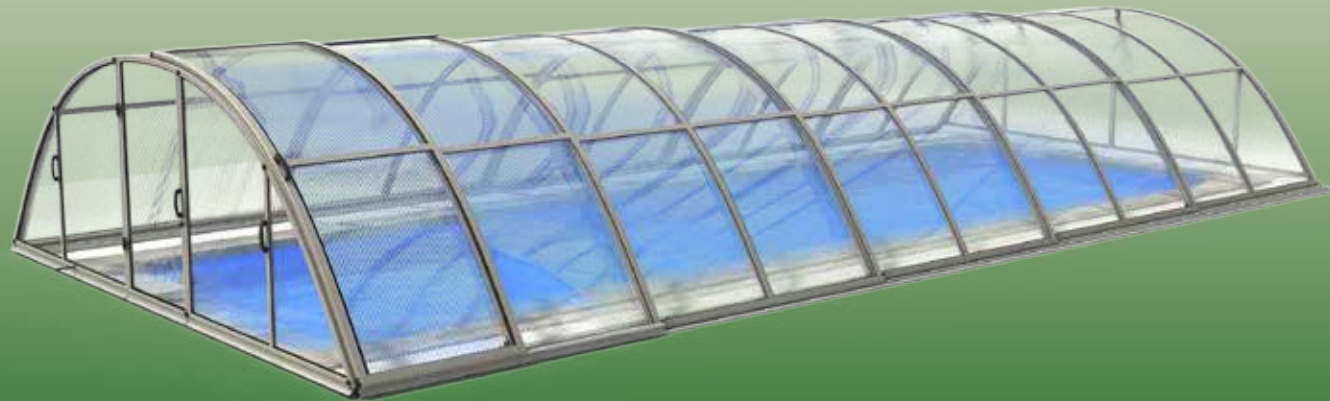

VERZE: 5. 10. 2017 / REVIZE: 5. 10. 2017

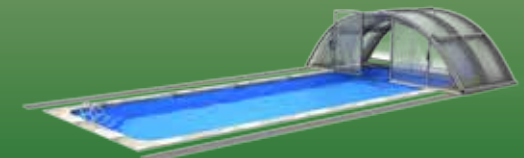
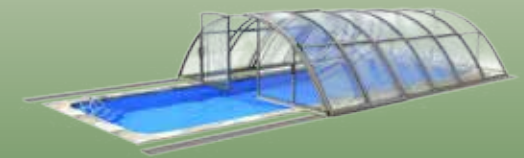
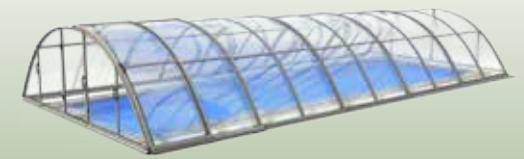
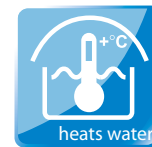

BG
 Тръгването на Слънцето: нова конструкция
 и конструкция ALBIXON - № P 90-200
 За повече информация относно всички подробности относно конструкцията
 на ALBIXON, моля свържете се с нашия център за обслужване на клиенти.

DE
 Schwimmplatzüberdachung: neue Konstruktion
 und Bauweise ALBIXON - № P 90-200
 Für weitere Informationen zu allen Details zu diesem Modell, das Ihnen
 zur Verfügung steht, kontaktieren Sie bitte unser Kundendienst.

ES
 Cubierta de piscinas: nueva forma
 y construcción ALBIXON - № P 90-200
 Para más detalles sobre el modelo, así como sobre todos los
 detalles de este modelo, contacte con nuestro servicio al cliente.

FR
 Niveaux de piscines: nouvelle forme
 et construction ALBIXON - № P 90-200
 Pour plus de détails sur ce modèle, ainsi que sur tous les
 détails de ce modèle, contactez notre service client.

HU
 Medencefedélzetek: új formák
 ALBIXON - № P 90-200
 A további információkért, illetve a részletekért, kérjük, forduljon
 ügyfélszolgálatunkhoz.

CN
 阳光房: 新设计
 阳光房 ALBIXON - № P 90-200
 欲了解有关此模型的更多详细信息, 请联系我们的
 客户服务中心。

LT
 Šilumos šilumos šilumos šilumos
 ALBIXON - № P 90-200
 Norisiu daugiau informacijos apie šį modelį, taip pat
 apie visus šio modelio detales.

PL
 Zadaszłonek: nowa konstrukcja
 i konstrukcja ALBIXON - № P 90-200
 Więcej informacji o wszystkich szczegółach konstrukcji
 ALBIXON, prosimy o kontakt z naszymi klientami.

RU
 Тёплый дом: новая конструкция
 и конструкция ALBIXON - № P 90-200
 Для получения дополнительной информации о всех
 деталях этой модели, пожалуйста, свяжитесь с нашей
 службой поддержки клиентов.

SL
 Nadzložnice: nova konstrukcija
 i konstrukcija ALBIXON - № P 90-200
 Za več informacij o vseh podrobnostih konstrukcije
 ALBIXON, prosimo, da se obrnete na našo
 službo za klijente.

CZ
 Střešní krytina: nová konstrukce
 a konstrukce ALBIXON - № P 90-200
 Pro více informací o všech podrobnostech konstrukce
 ALBIXON, prosíme o kontakt s našimi
 zákazníky.

DK
 Bænkoverdækning: ny konstruktion
 og konstruktion ALBIXON - № P 90-200
 For mere information om alle detaljer til dette
 model, bedes du kontakte vores kundeservice.

EE
 Basinalikatted: uus konstruktsioon
 ja konstruktsioon ALBIXON - № P 90-200
 Lisateavust selle mudeli kohta, samuti selle mudeli
 üksikasjalike detailide kohta, palun võtta
 ühendust meie klienditeenindusega.

GB
 The swimming pool enclosure: new design
 and construction ALBIXON - № P 90-200
 For more information on all the details of this
 model, please contact our customer service.

HR
 Nadzložnice: nova konstrukcija
 i konstrukcija ALBIXON - № P 90-200
 Za više informacija o svim detaljima konstrukcije
 ALBIXON, molimo vas da se obratite našoj
 službi za klijente.

IT
 Copertura per piscine: nuova forma
 e costruzione ALBIXON - № P 90-200
 Per maggiori informazioni su tutti i dettagli della
 costruzione ALBIXON, vi invitiamo a contattare il
 nostro servizio clienti.

LV
 Bāzēņu jumts: jauna konstrukcija
 un konstrukcija ALBIXON - № P 90-200
 Par vairāk informāciju par šīs konstrukcijas
 visām detaļām, lūgums sazināties ar mūsu
 klientu dienestu.

RO
 Acoperitură pentru piscină: nouă
 construcție și construcție ALBIXON - № P 90-200
 Pentru mai multe informații despre toate
 detaliile acestei construcții ALBIXON, vă
 rugăm să contactați serviciul nostru
 de clienți.

SE
 Pooltak: ny konstruktion
 och konstruktion ALBIXON - № P 90-200
 För mer information om alla detaljer för detta
 modell, vänligen kontakta vår kundtjänst.

SK
 Střešní krytina: nová konstrukcia
 a konstrukcia ALBIXON - № P 90-200
 Pre viac informácií o všetkých podrobnostiach
 konstrukcie ALBIXON, prosíme o kontakt
 s našimi zákazníkmi.

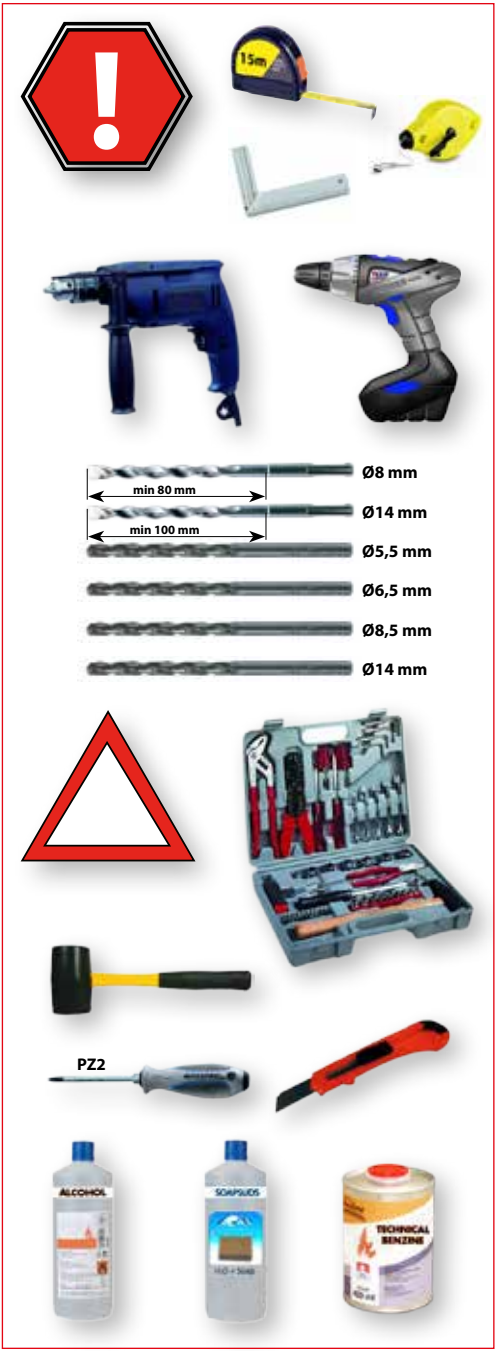

DIN 7982
4,8 x 13
24x
1

650.01.8811.2

20x
2

AN 9051
6,3 x 50
44x
3

007.20.1501.2

6x
4

DIN 7976
6,3 x 38
6x
5

650.01.0021.2

4x
6

007.02.0030.2

ø4 x 10
100x
7

007.20.1605.2

1x
8

007.10.7012.2

ø8 x 80
140x
9

007.90.7022.2

4x
10

007.02.0092.2

ø4 x 14
8x
11

007.90.4505.2

4x
12

AN 9051
6,3 x 38
24x
13

ø4,2
1x
14

1x
17

1x
18

097.02.0046.2

4x
19

097.02.0047.2

4x
20

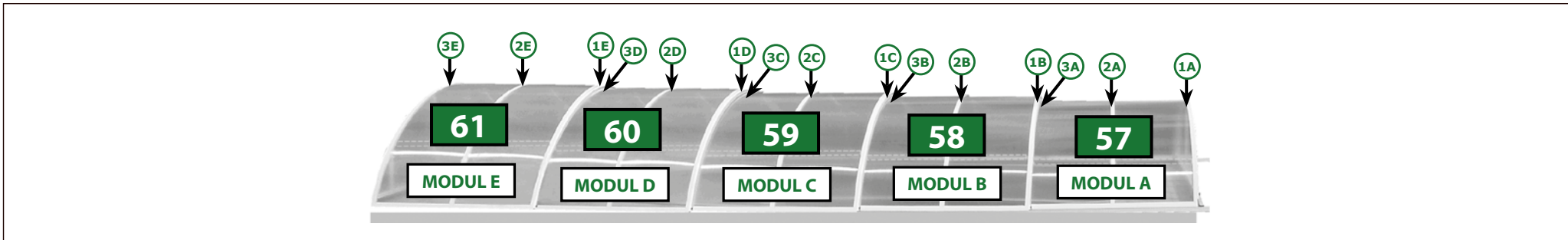

MODUL A

1A	1x	21
2A	1x	22
3A	1x	23

MODUL B

1B	1x	24
2B	1x	25
3B	1x	26

MODUL C

1C	1x	27
2C	1x	28
3C	1x	29



MODUL D

1D	1x	30
2D	1x	31
3D	1x	32

MODULE

1E	1x	33
2E	1x	34
3E	1x	35

1041 mm
40x
36

8x
37



A
3230 mm
2x
40

A
3230 mm
2x
41

B
3230 mm
2x
42



B
3230 mm
2x
43

C
1040 mm
2x
44

C
1040 mm
2x
45

D
3230 mm
2x
46

D
3230 mm
2x
47

3230 mm
30x
48

1040 mm
10x
49

MODULE
1x
50

	MODULE
1x	
51	

	MODUL D
MODUL C	
MODUL B	
3x	
52	

	MODUL D
MODUL C	
MODUL B	
3x	
53	

	MODUL A
1x	
54	

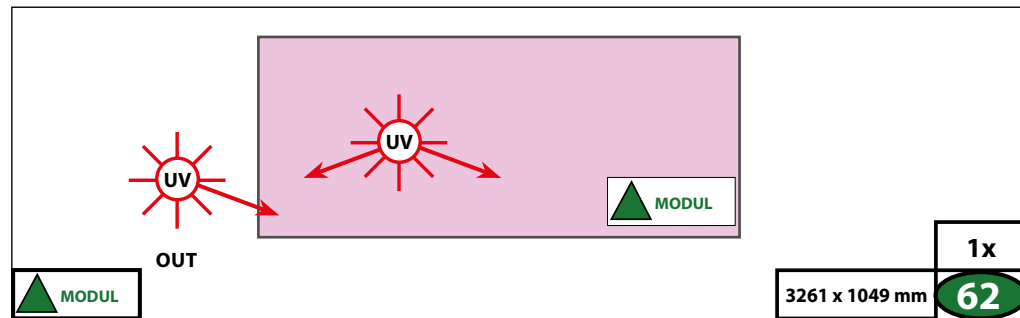
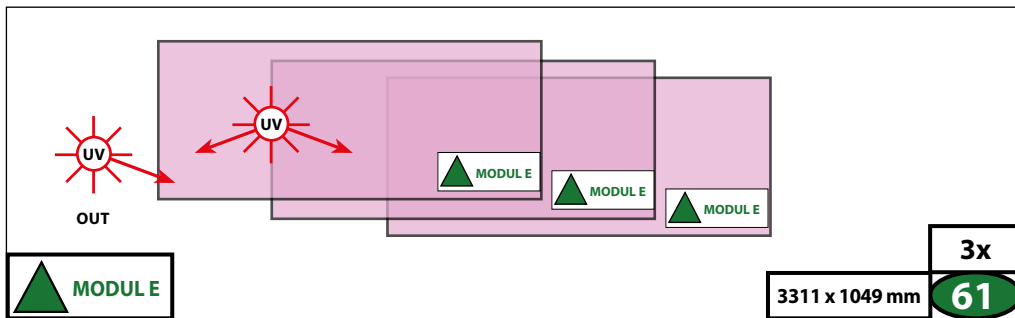
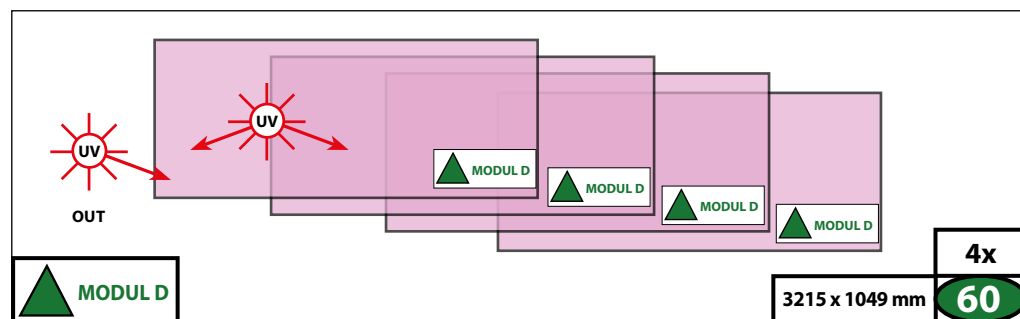
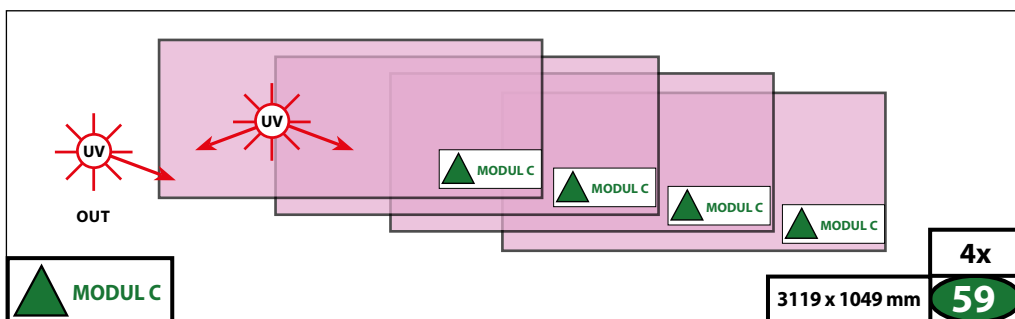
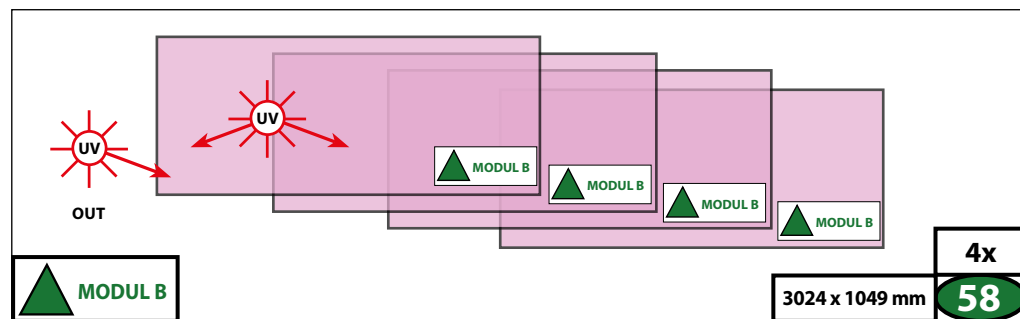
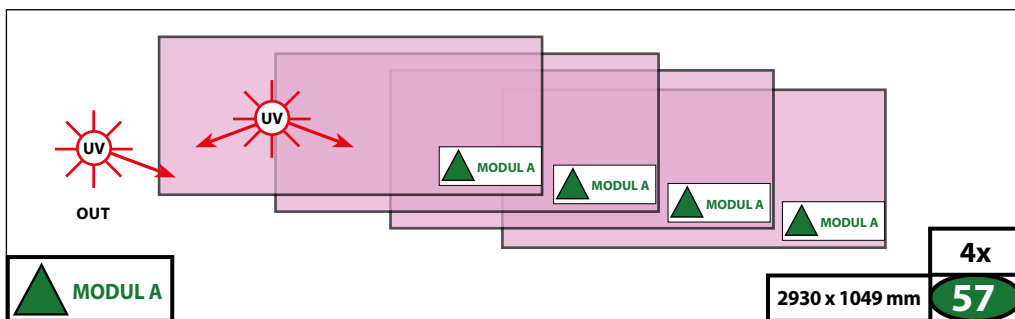
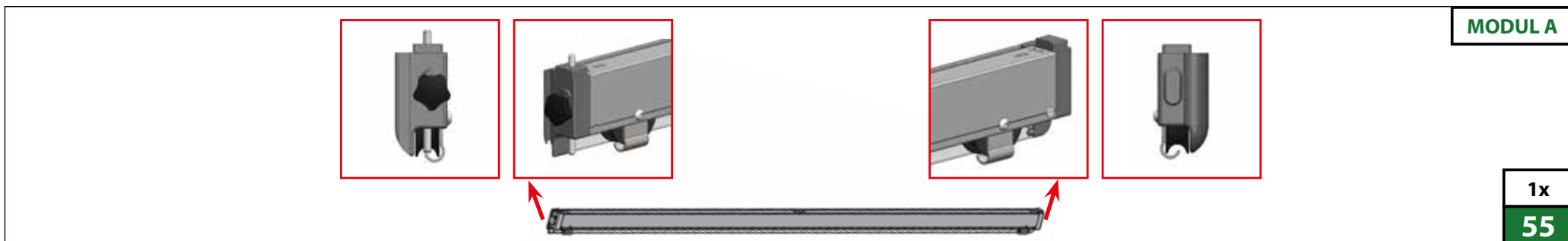



1x
63

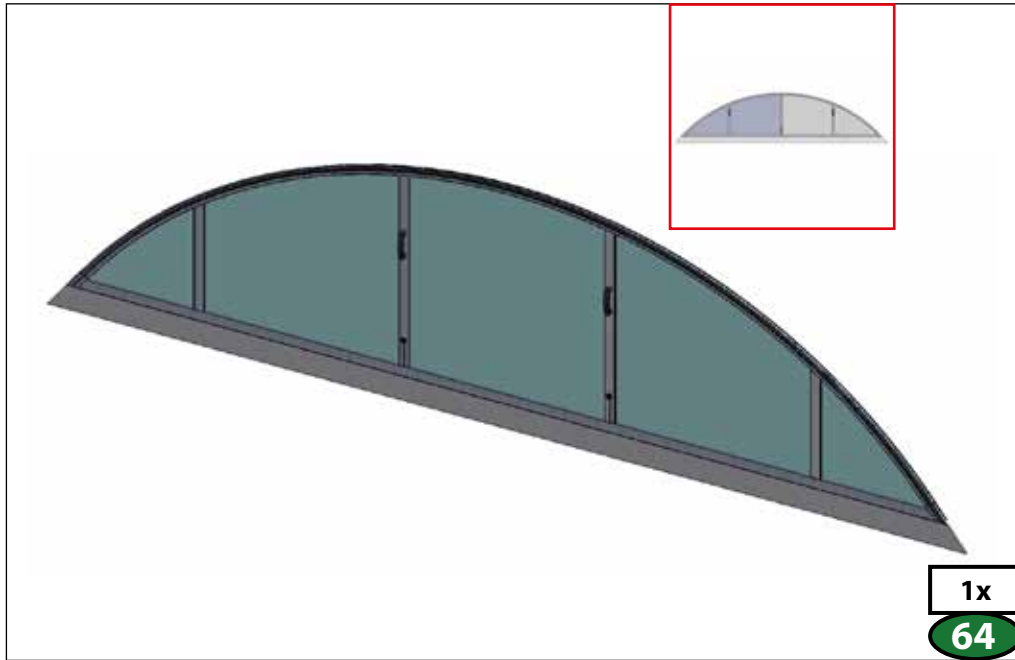

1x
64

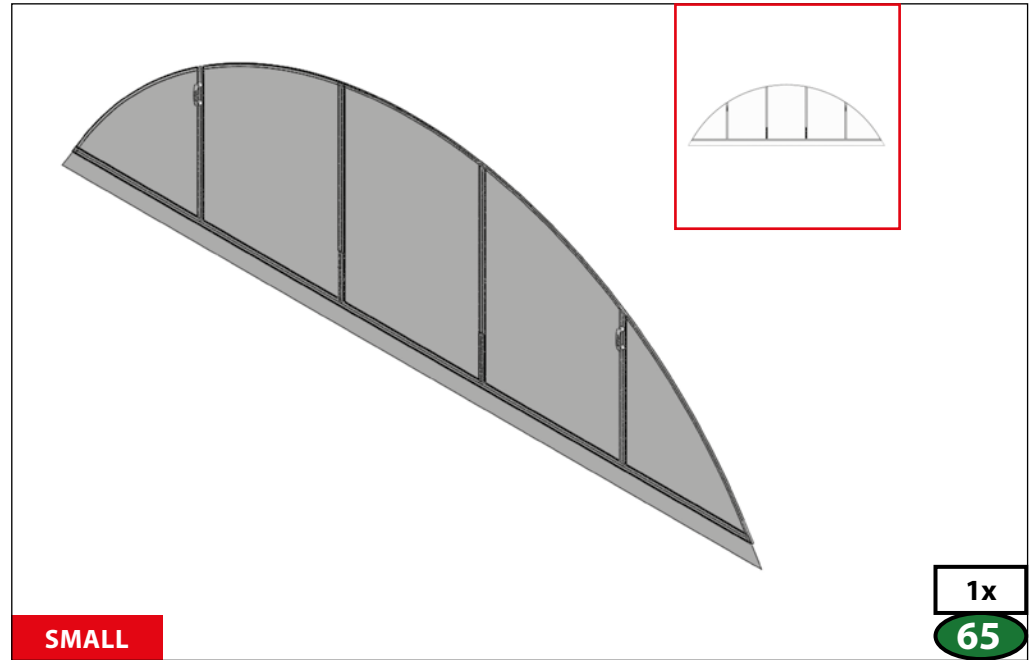

1x
65

SMALL



1x
69

1x
70

1x
2150 mm
71

1x
2150 mm
72

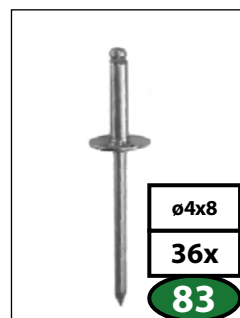
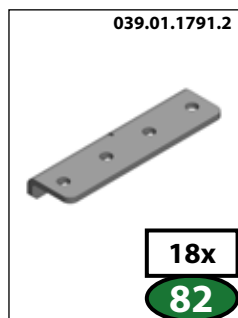
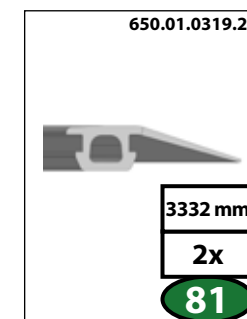
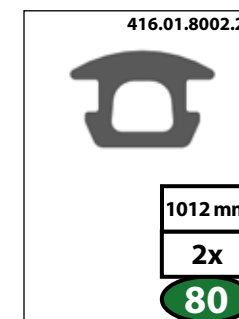
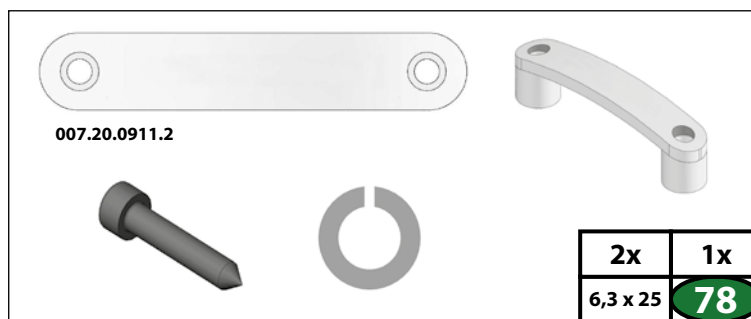
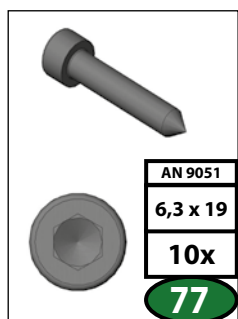
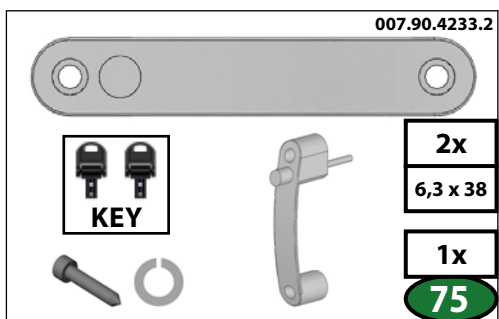
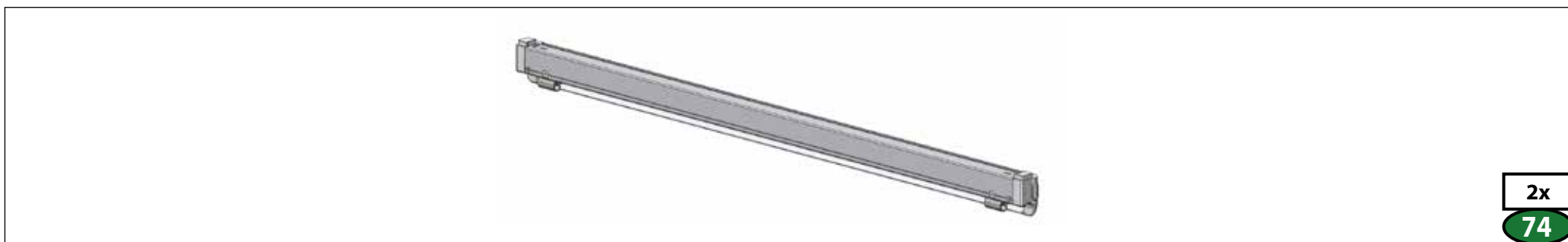
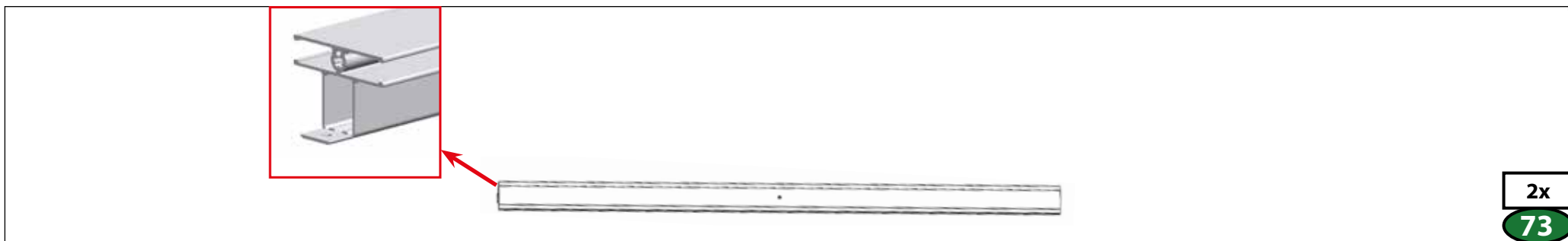



Diagram for Modul A showing dimensions and quantity:

2 930 mm	8x
1 030 mm	8x

MODUL A  **92**

Diagram for Modul B showing dimensions and quantity:

3 024 mm	8x
1 030 mm	8x

MODUL B  **93**

Diagram for Modul C showing dimensions and quantity:

3 119 mm	8x
1 030 mm	8x

MODUL C  **94**

Diagram for Modul D showing dimensions and quantity:

3 215 mm	8x
1 030 mm	8x

MODUL D  **95**

Diagram for Modul E showing dimensions and quantity:

3 311 mm	6x
1 030 mm	6x



MODUL E  **96**

Diagram for Modul showing dimensions and quantity:

3 261 mm	2x
1 030 mm	2x

MODUL  **97**

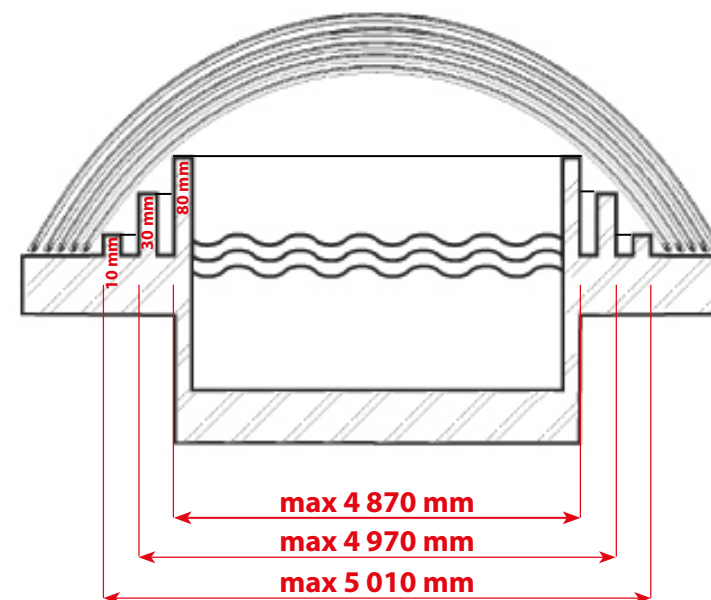
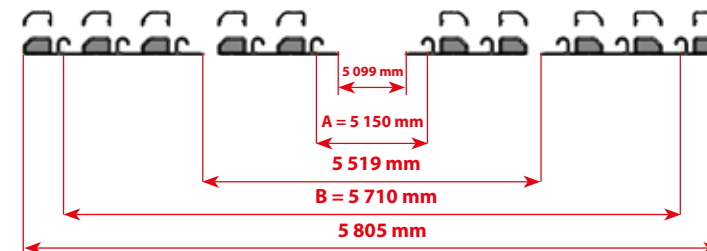
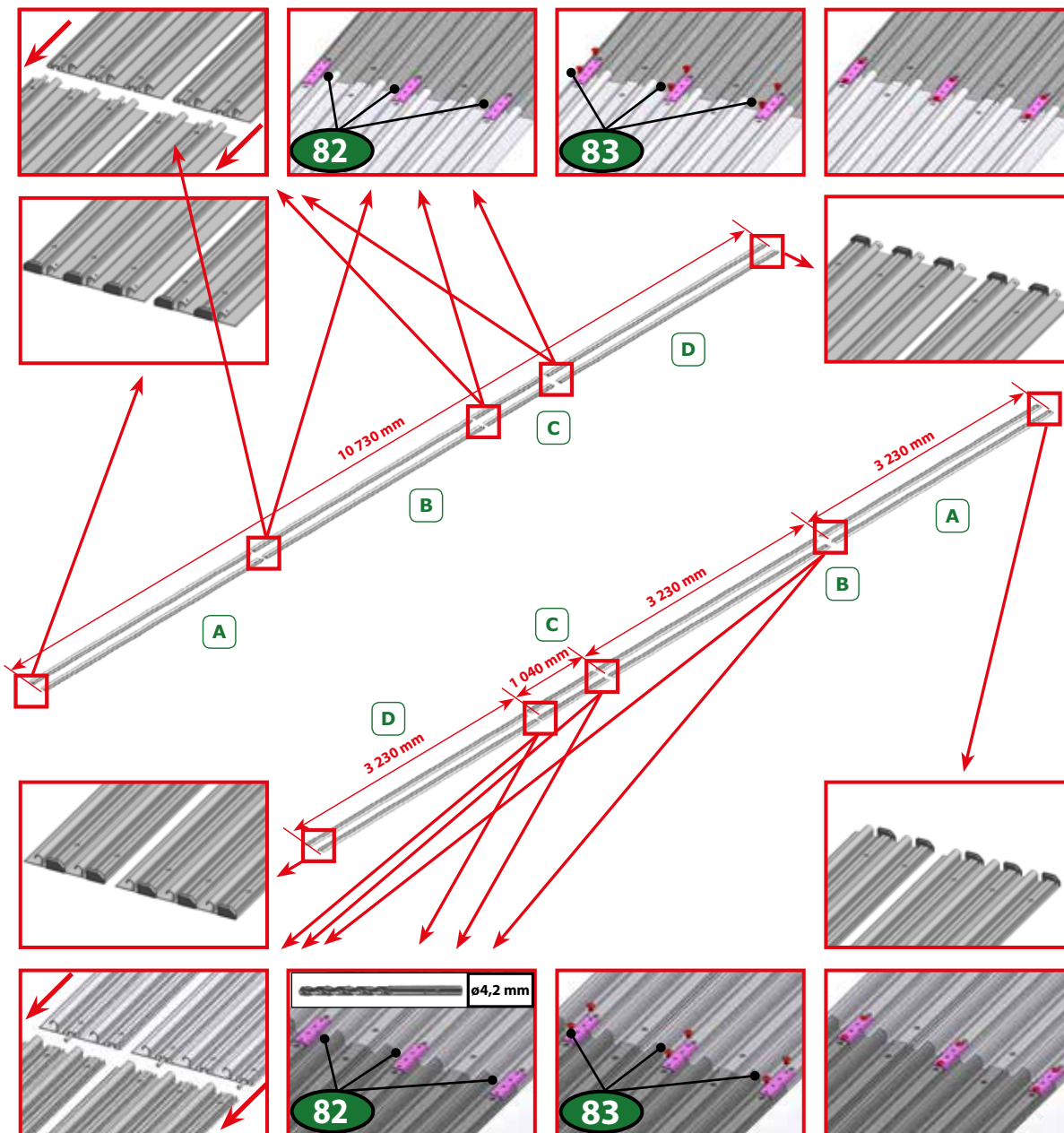

2x	40	2x	44
2x	41	2x	45
2x	42	2x	46
2x	43	2x	47

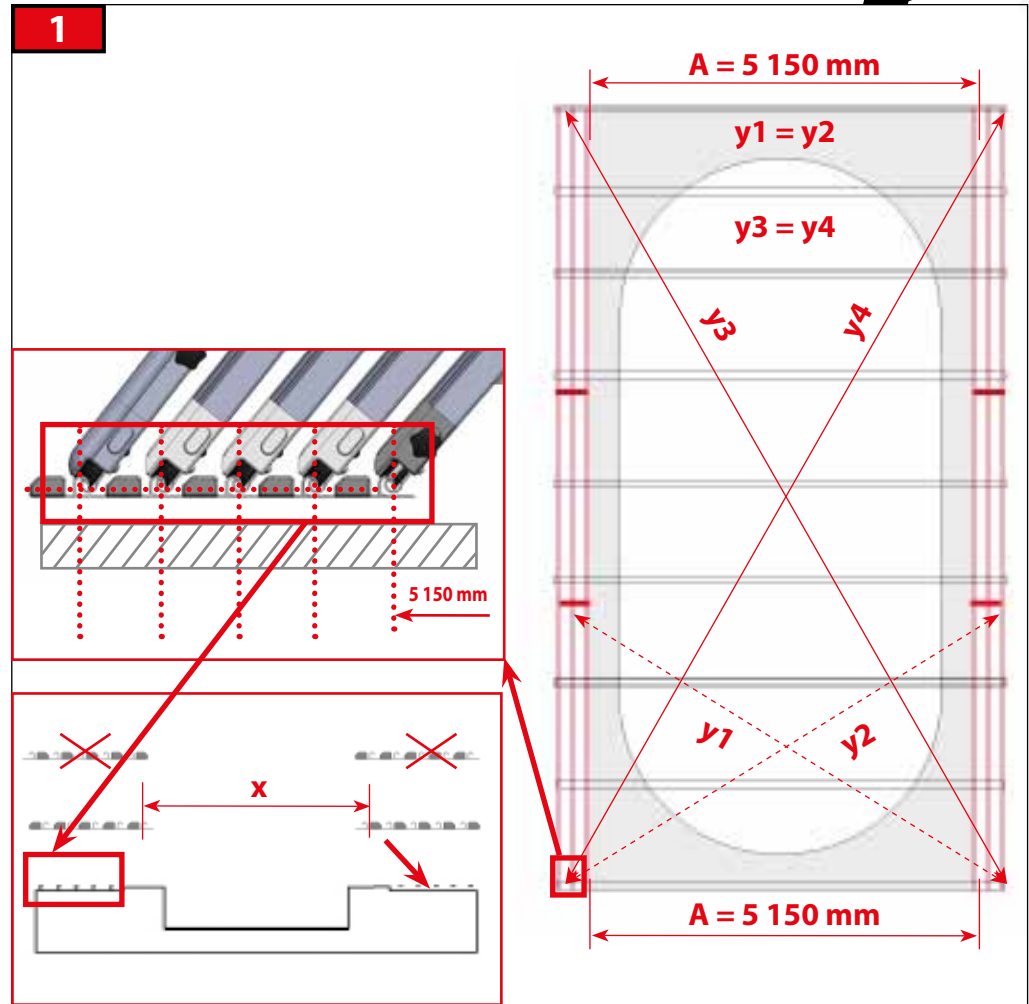
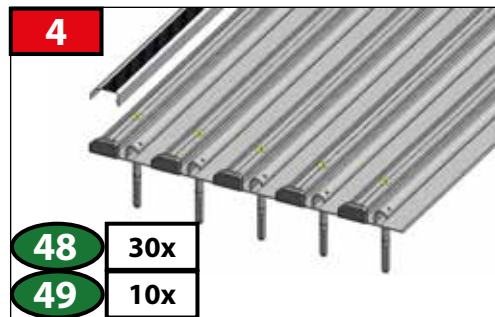
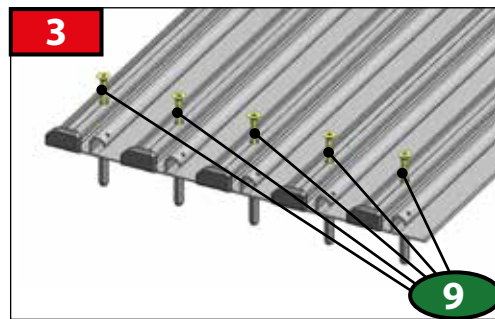
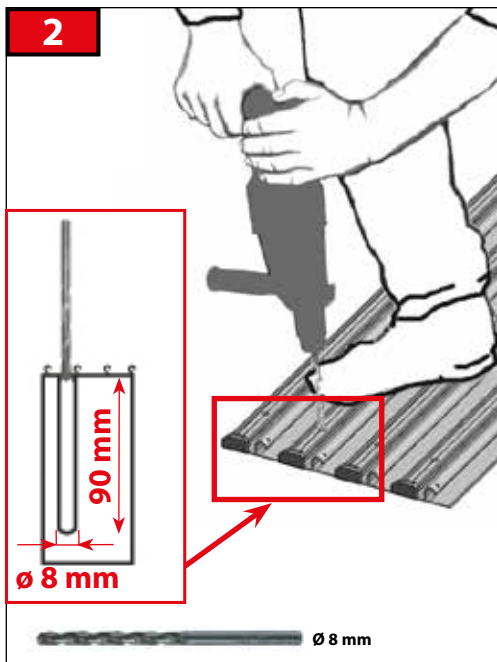
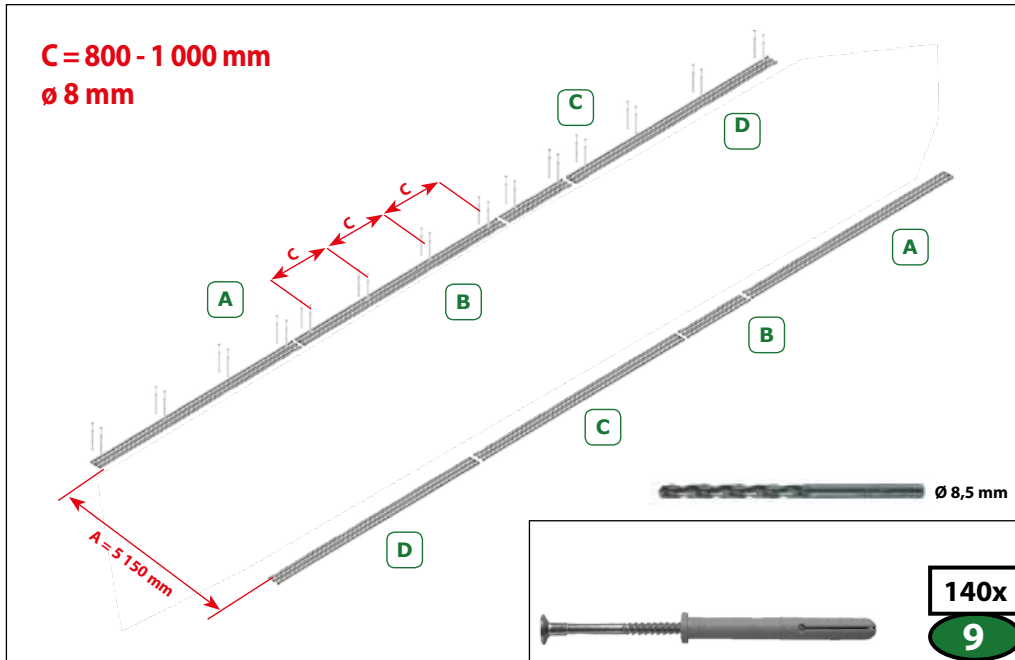

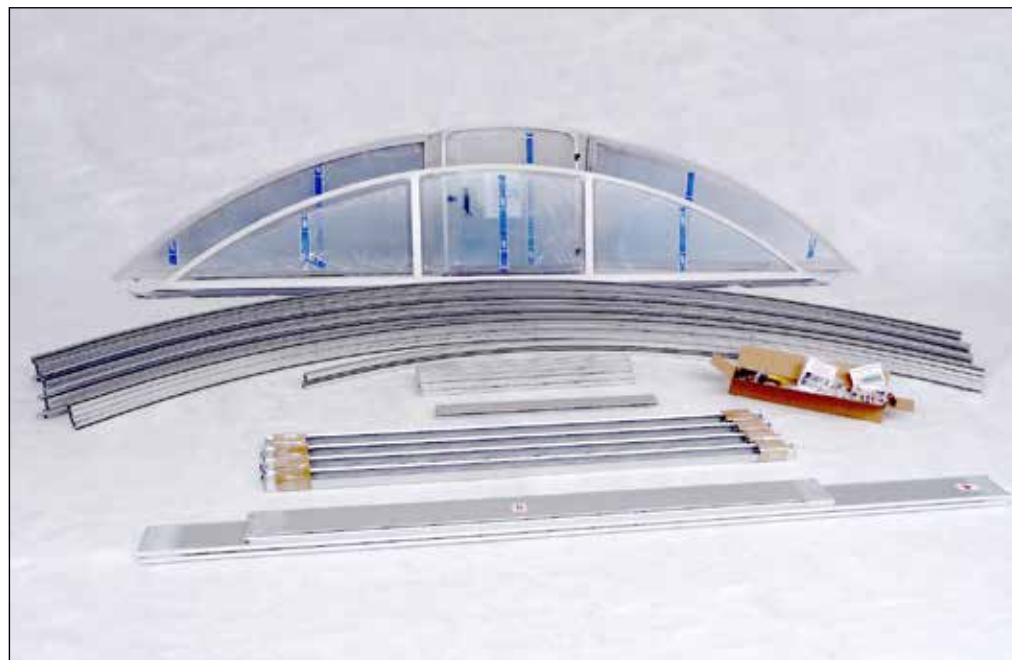

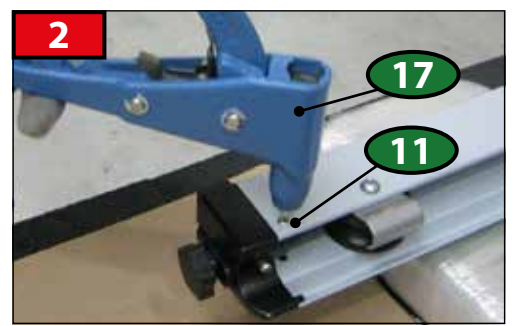
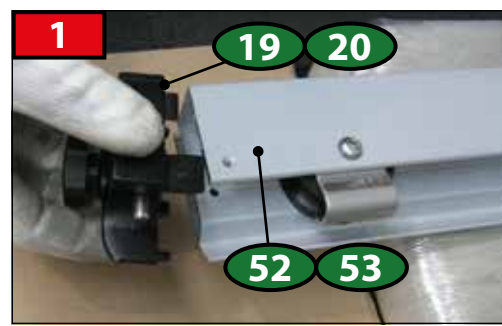
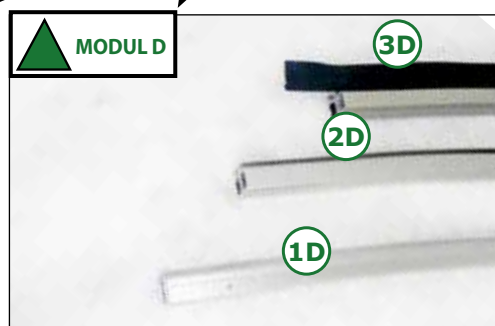
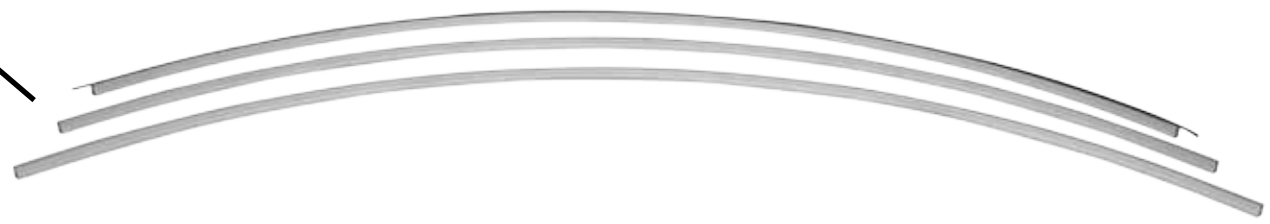
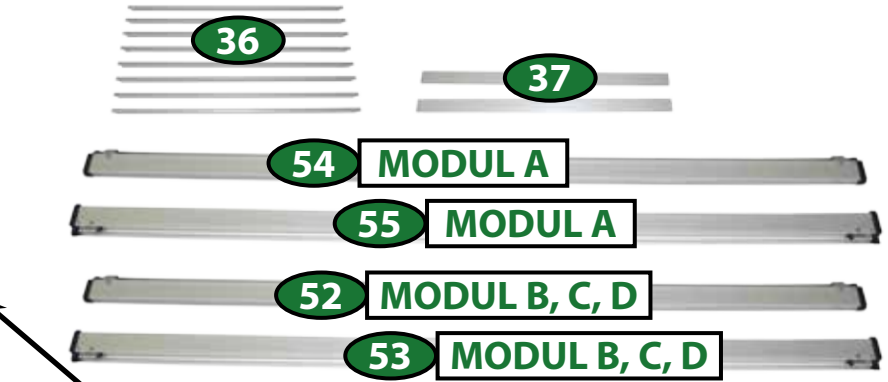
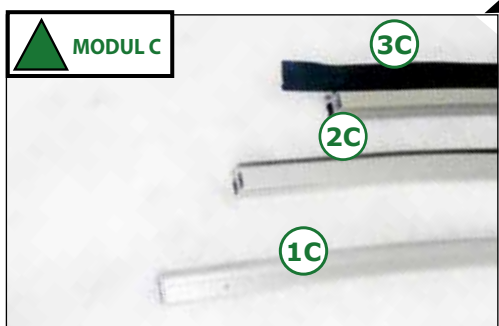
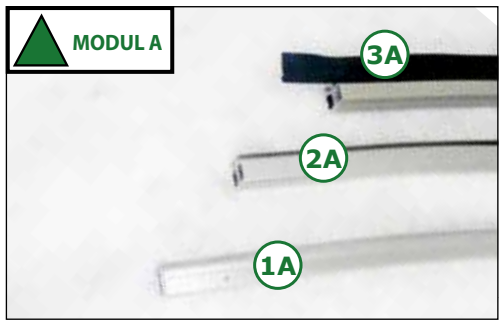
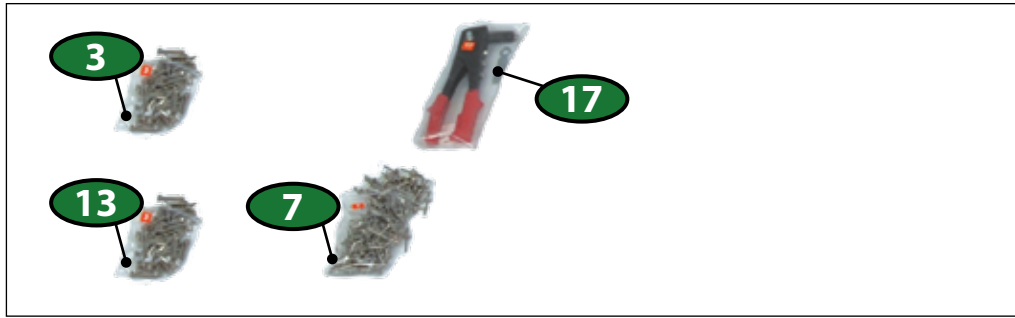

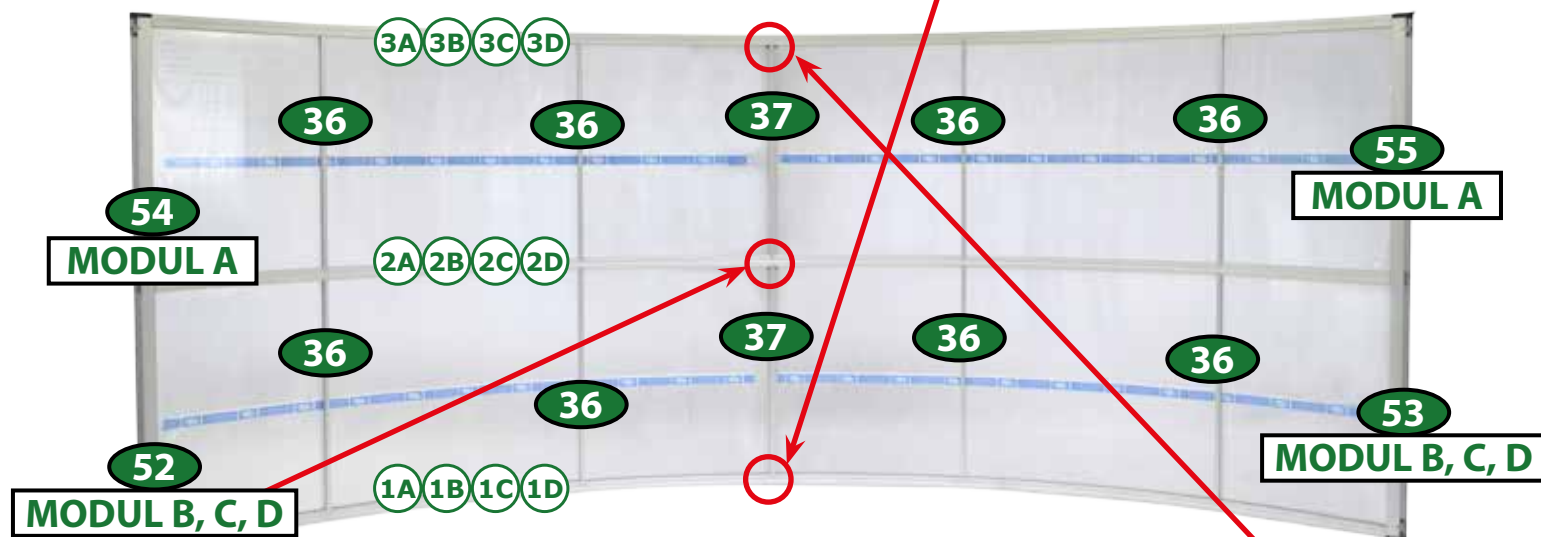
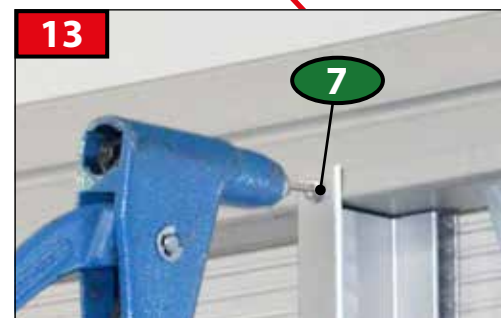
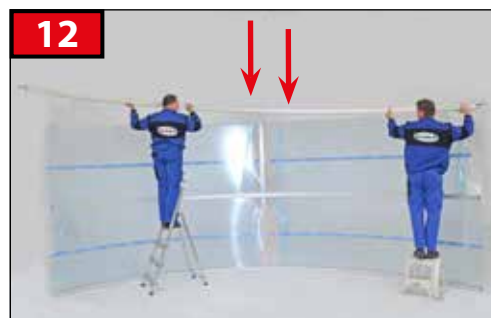
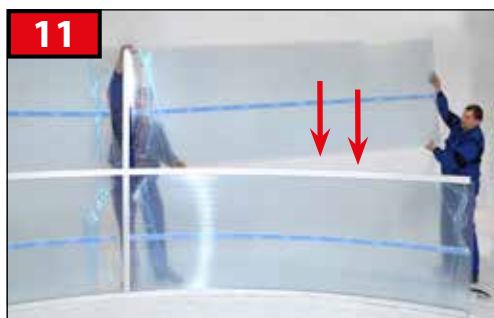
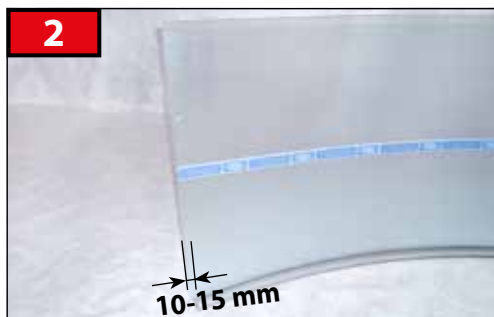

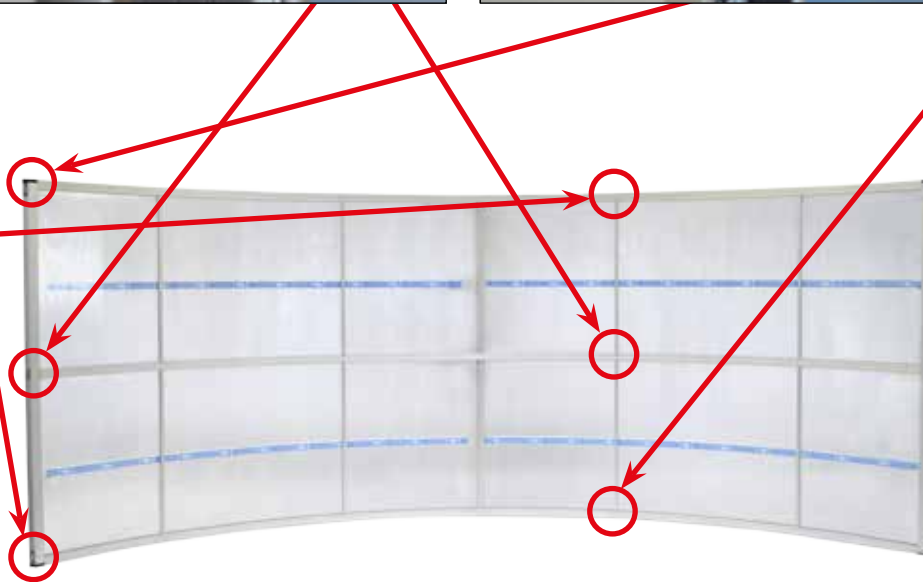
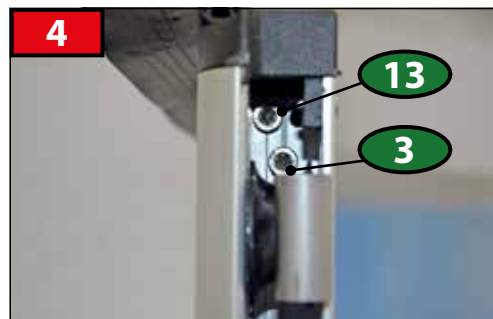
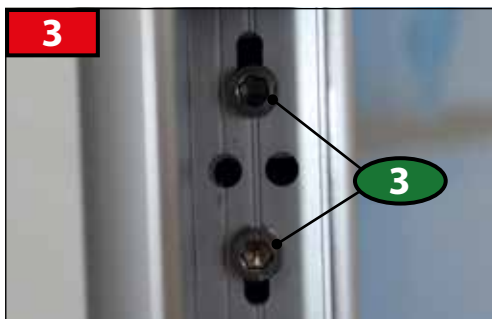

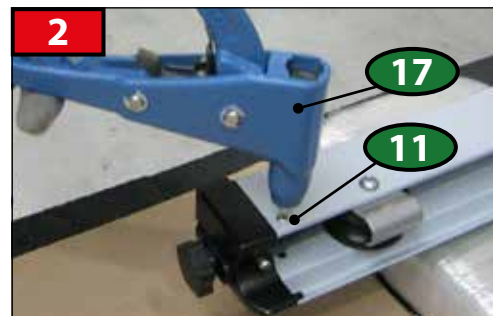
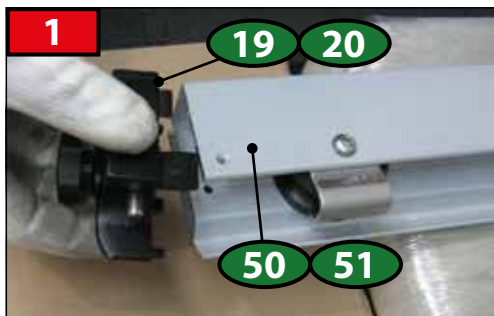
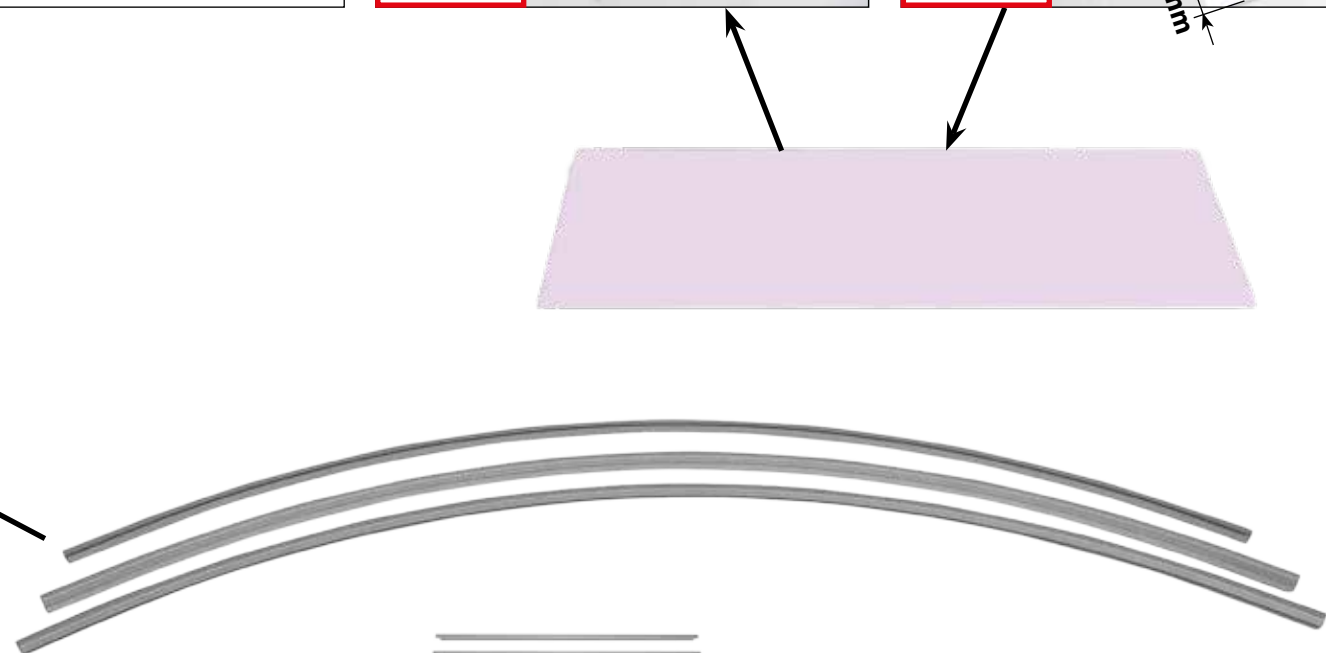
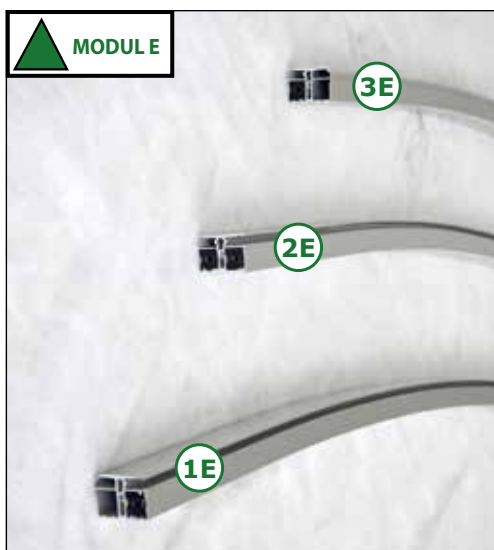
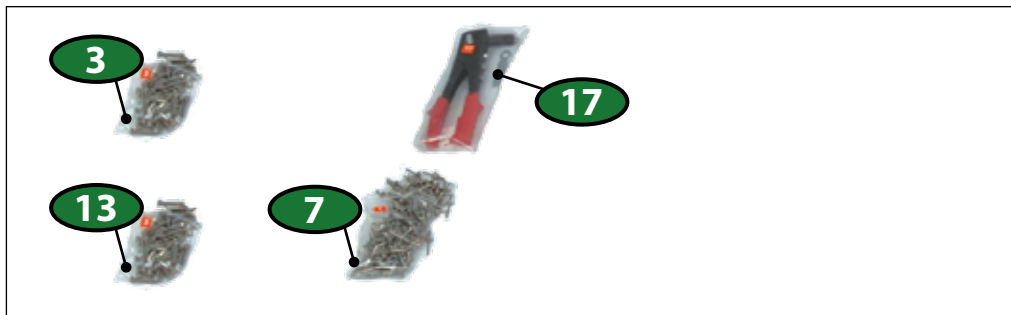



DOOR LEFT

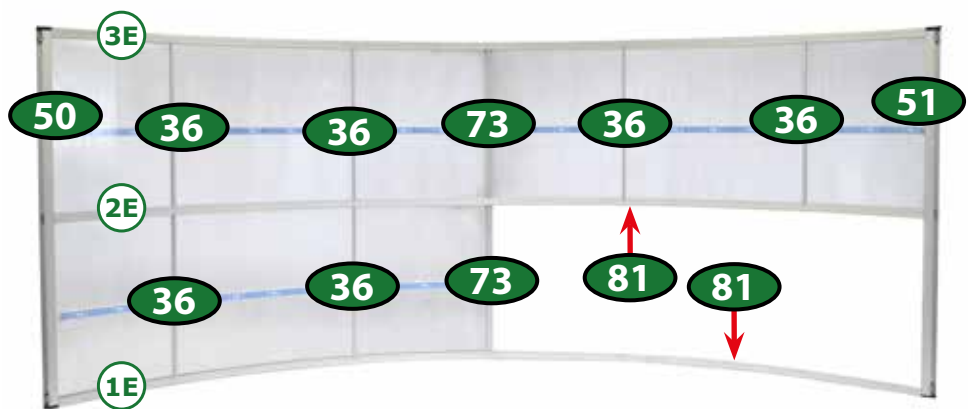
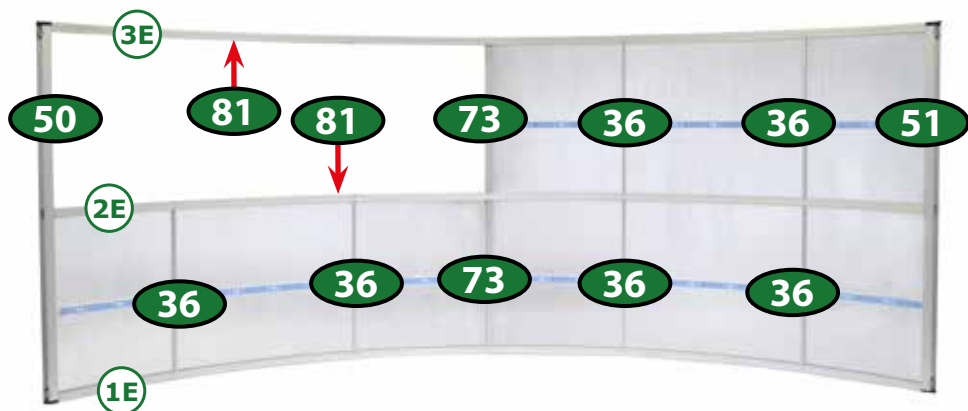

DOOR RIGHT

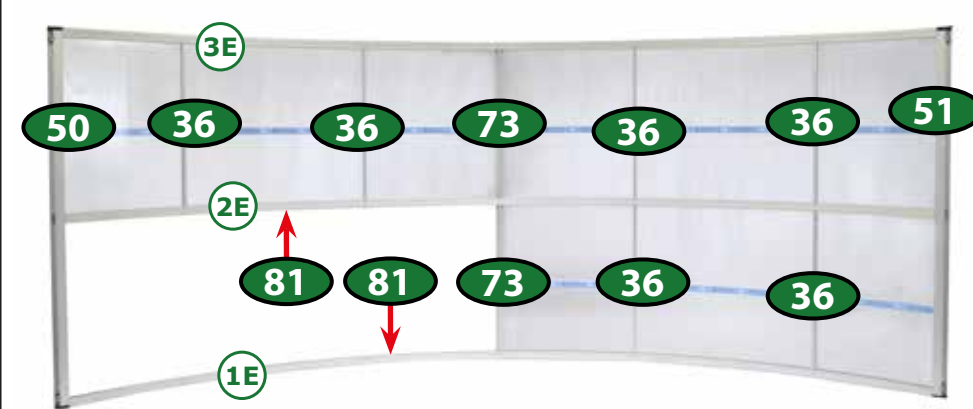
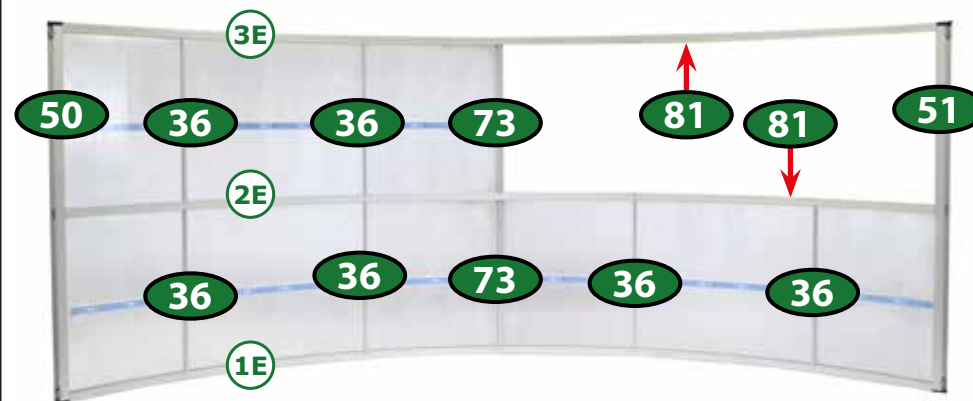

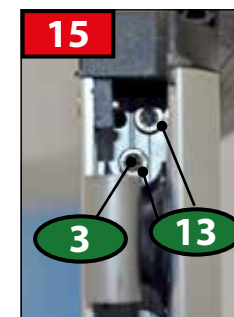
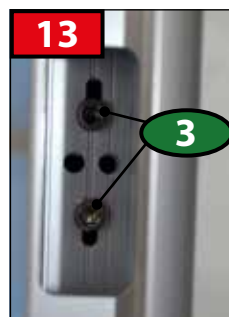
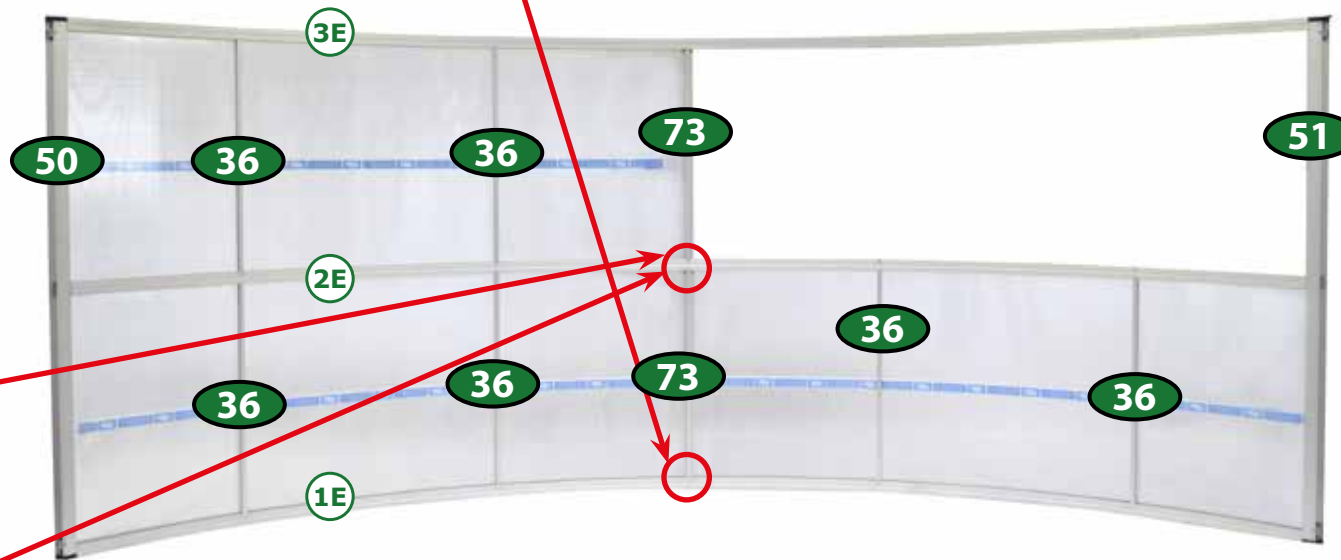

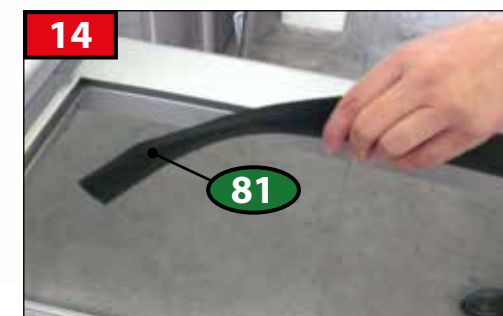
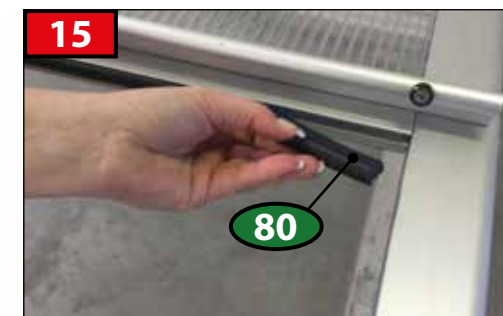
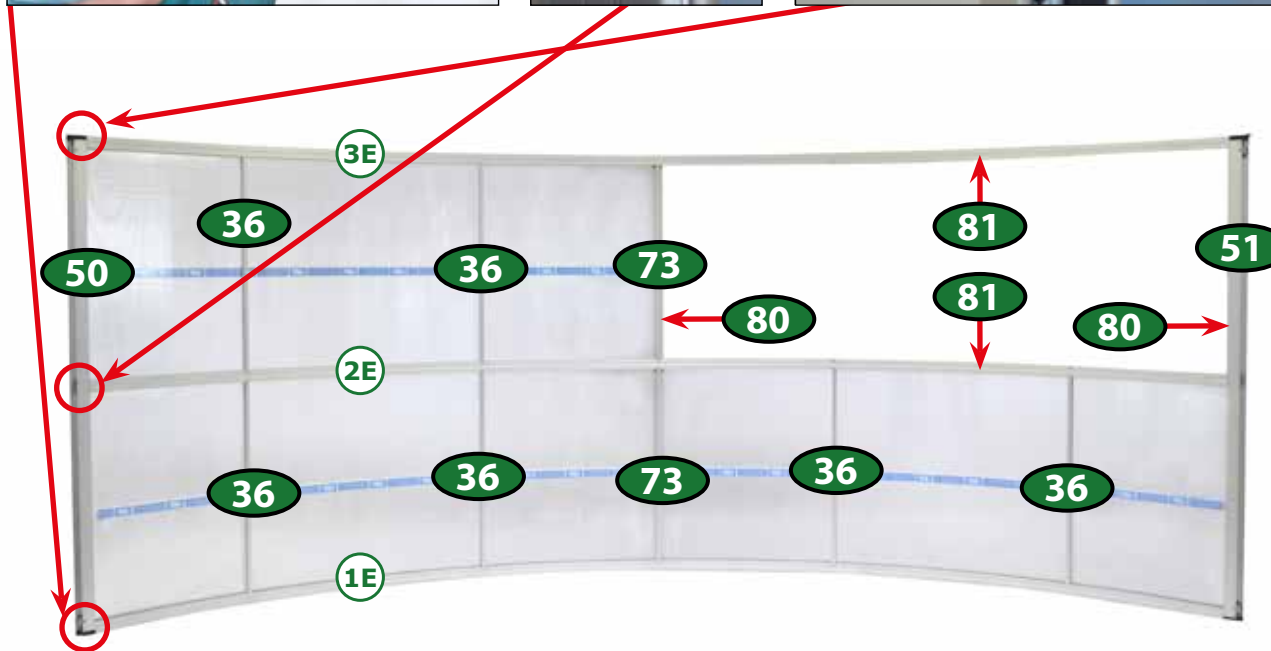
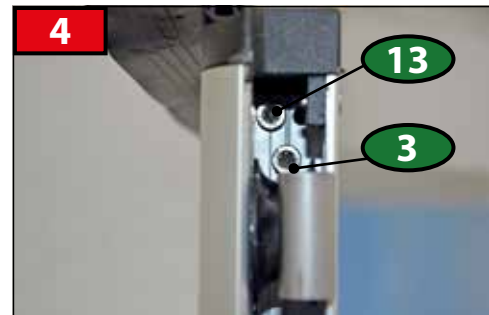
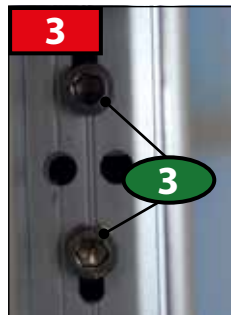

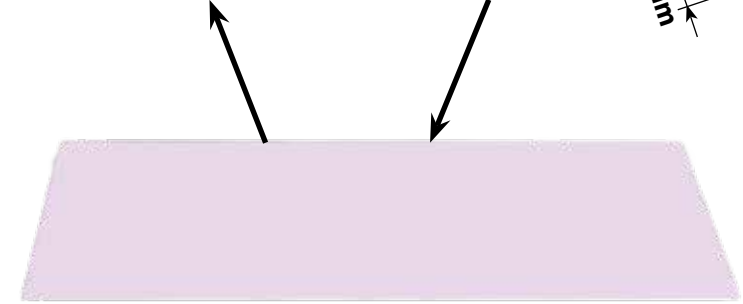
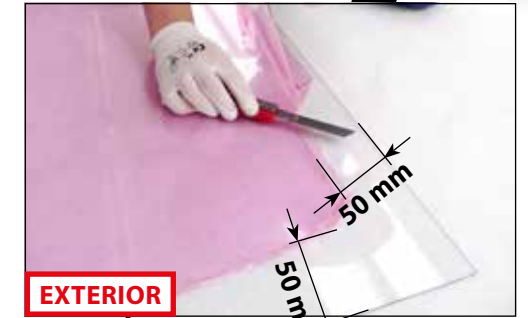
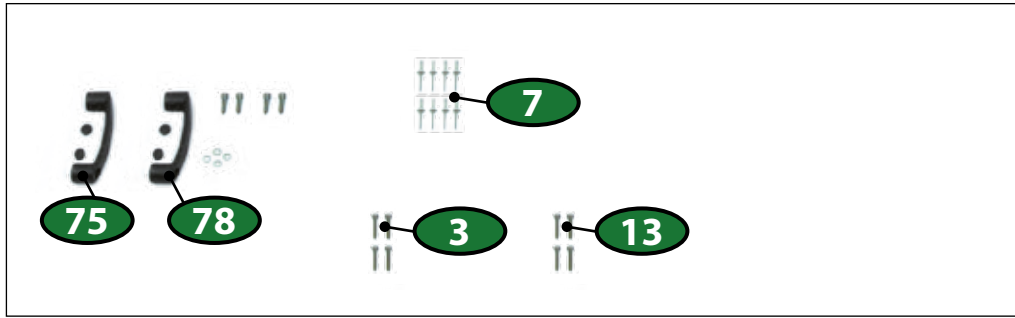

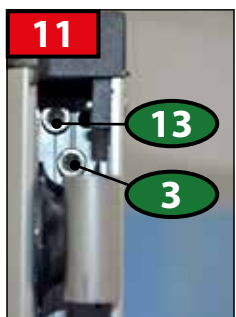
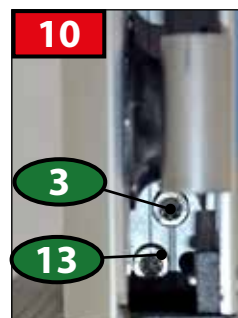
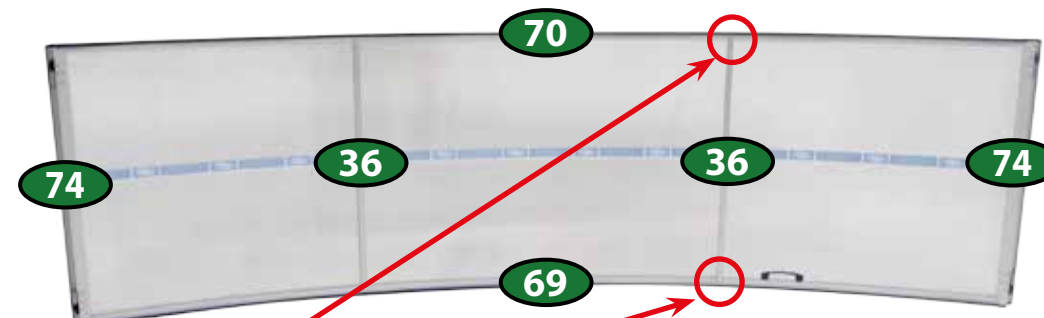

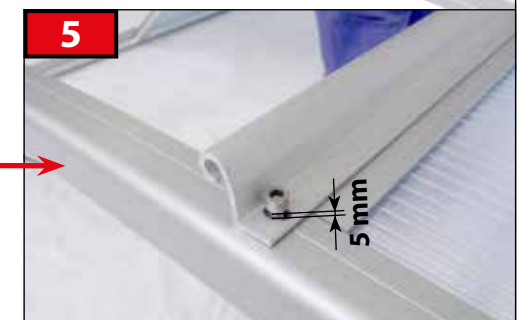
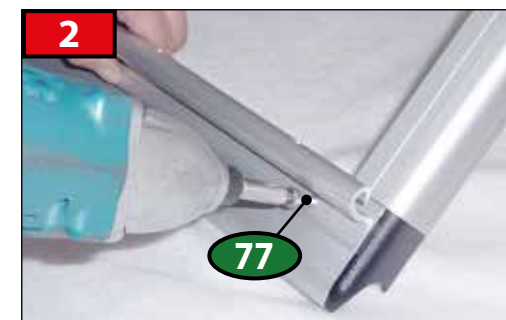
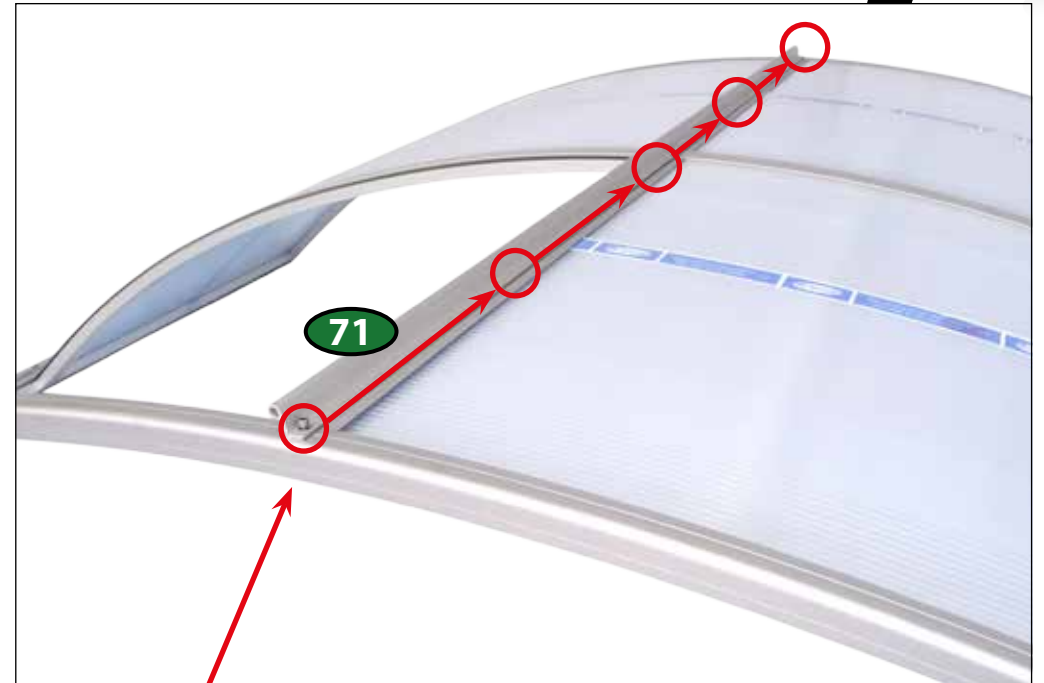

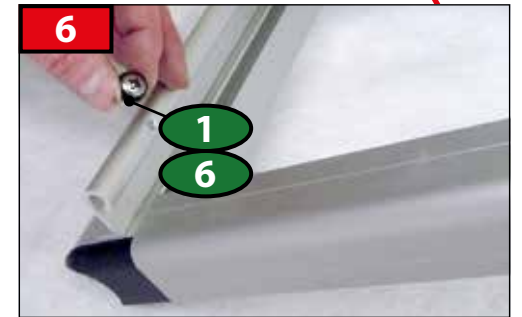
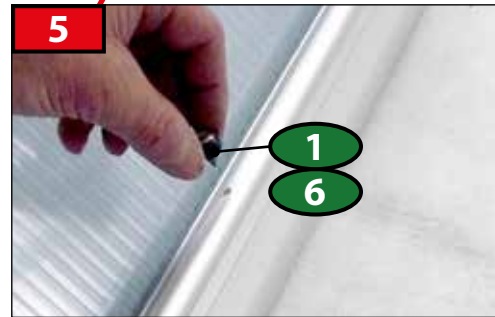
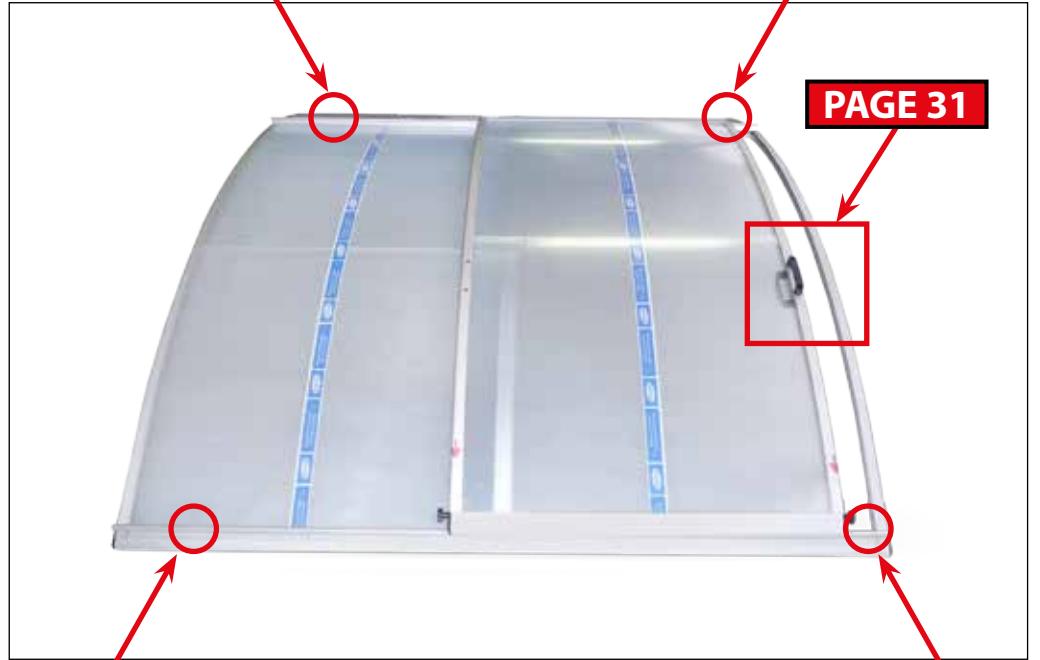
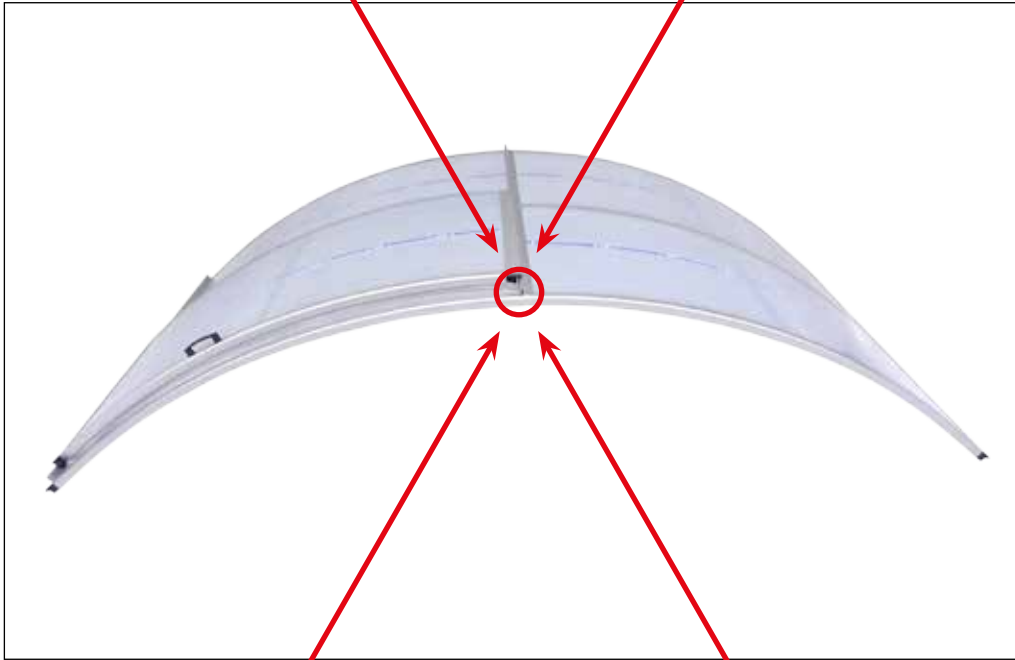
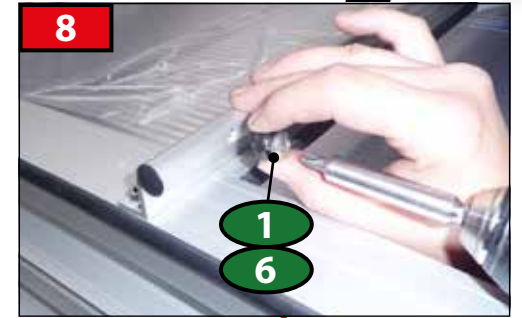

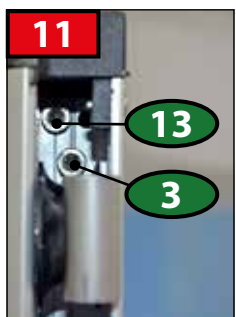
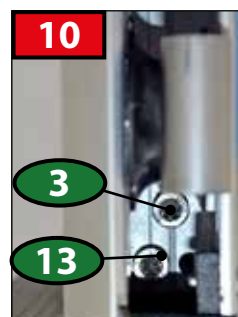
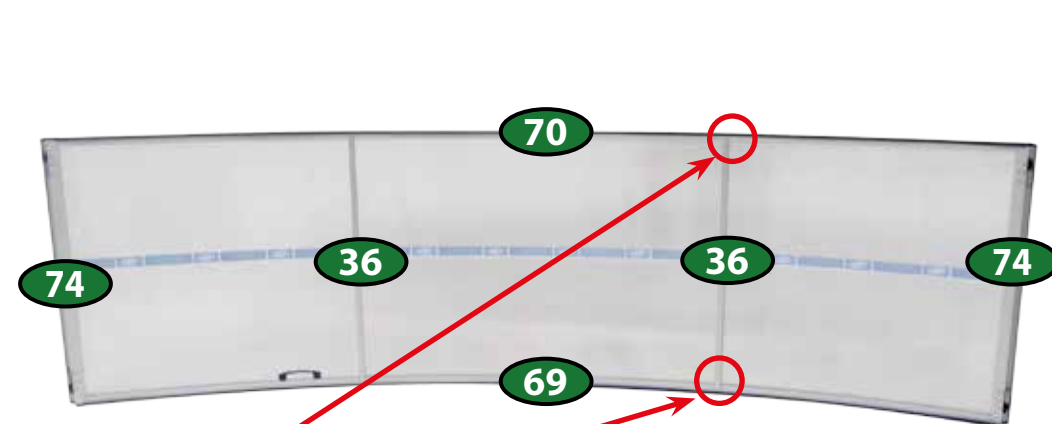

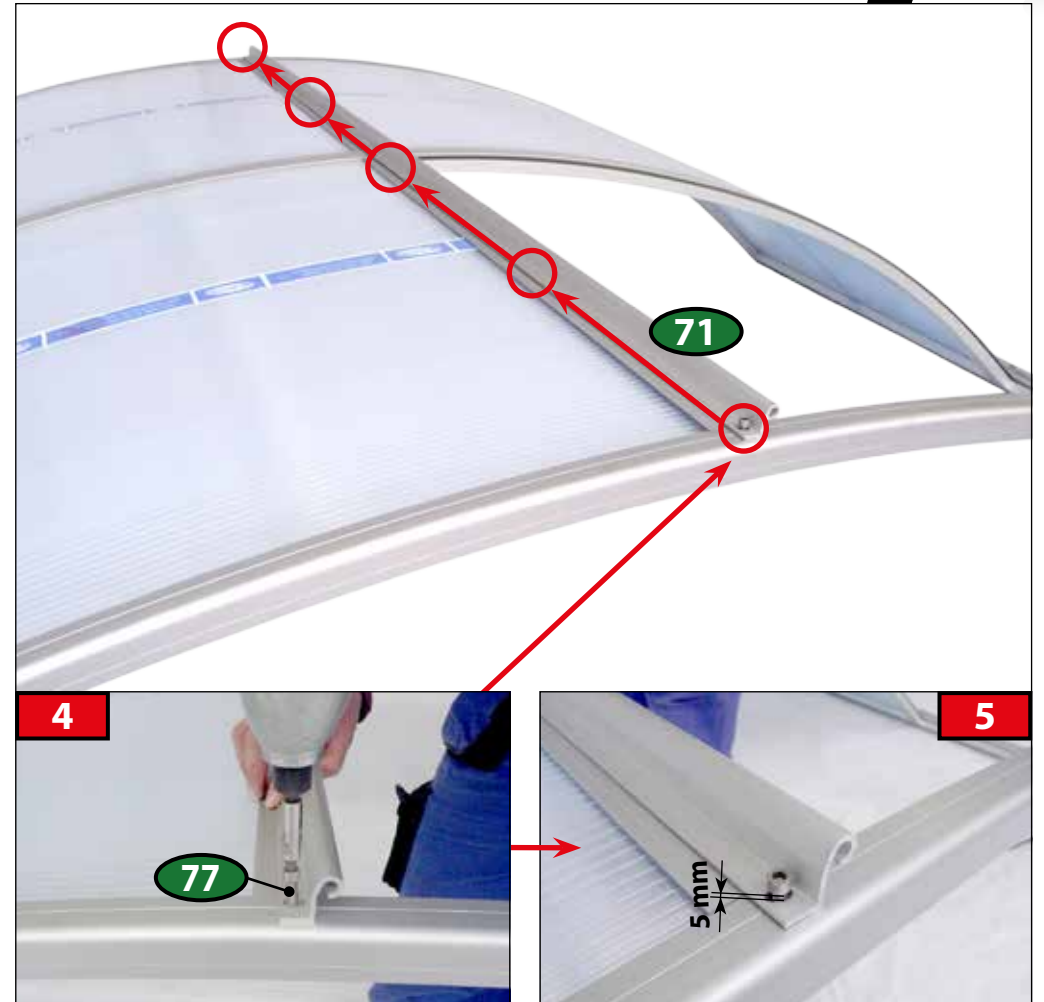

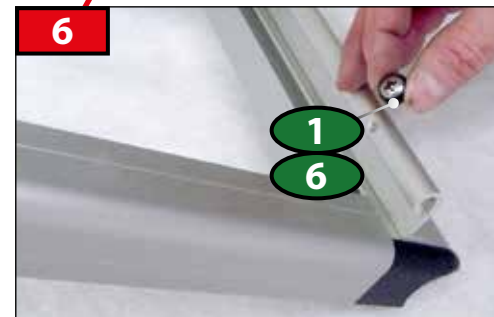
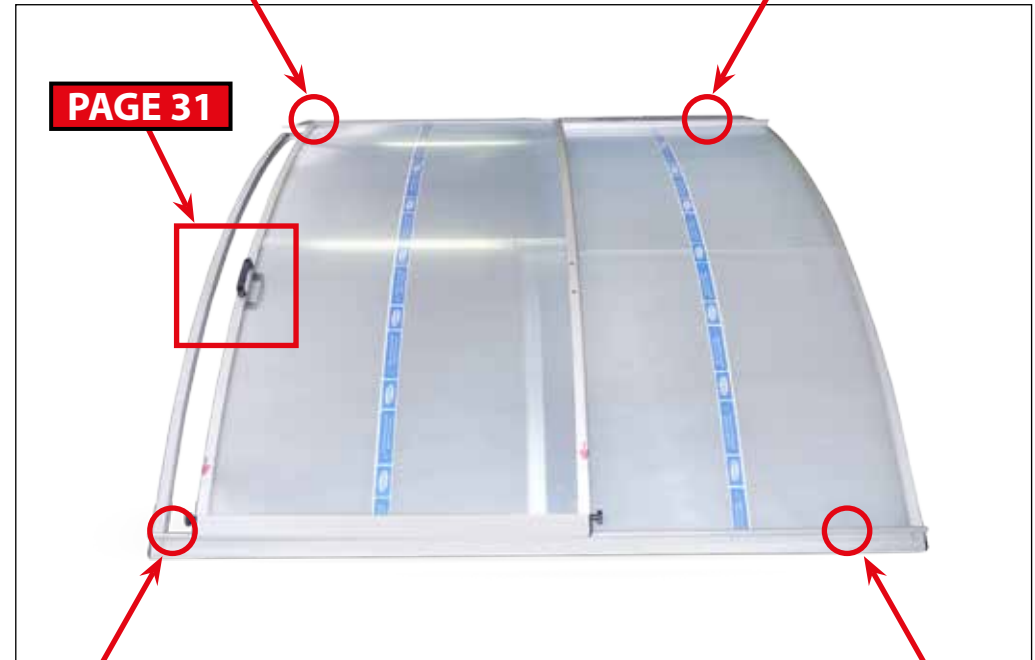
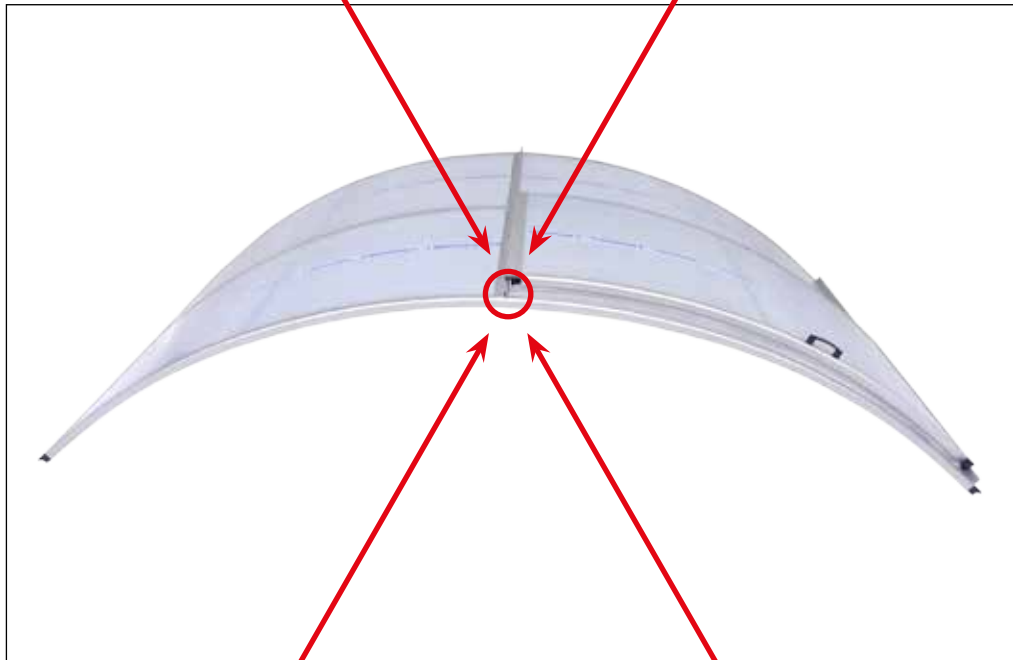
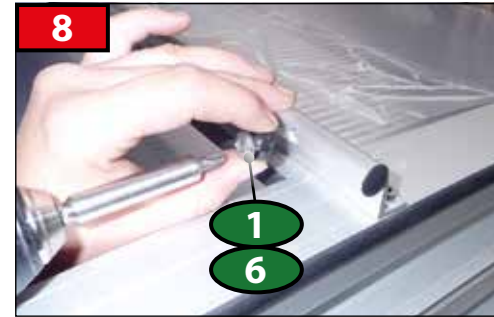

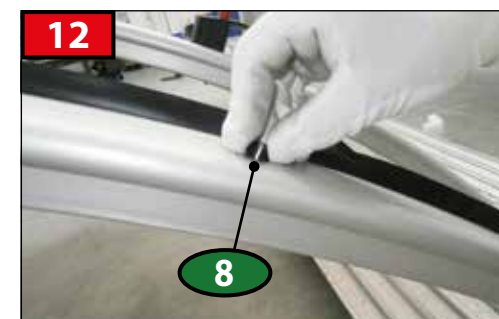
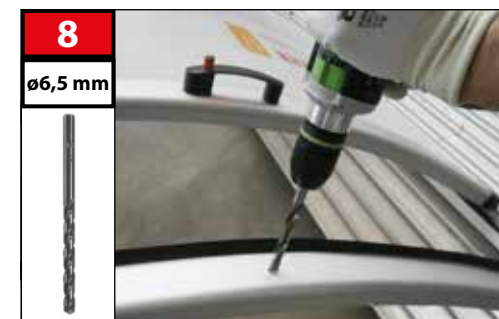
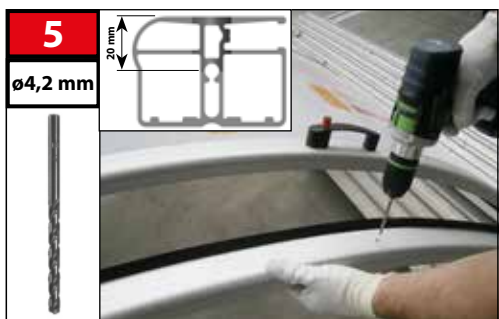

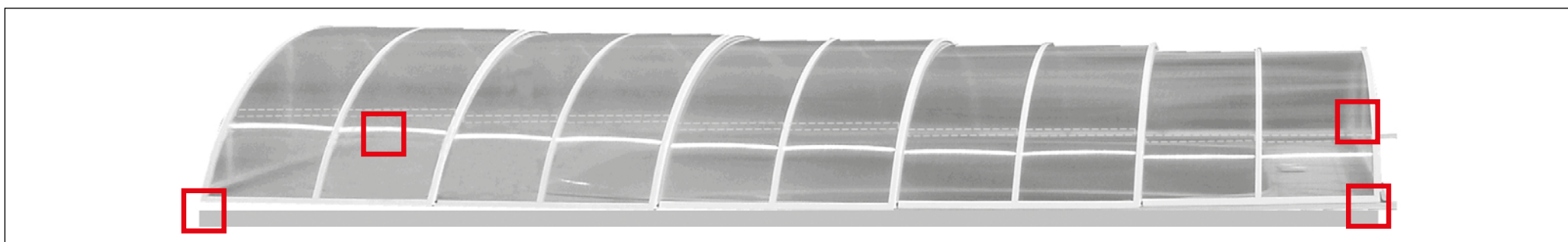
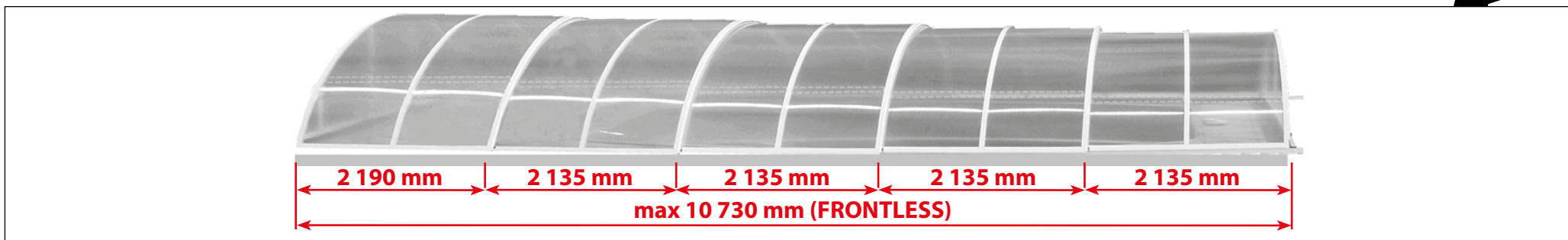

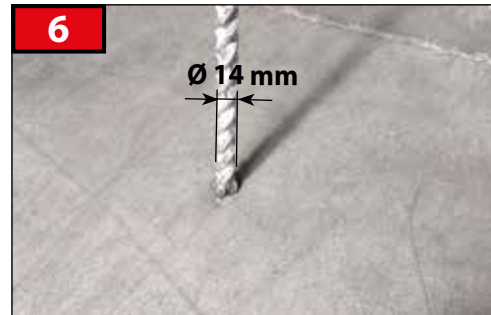
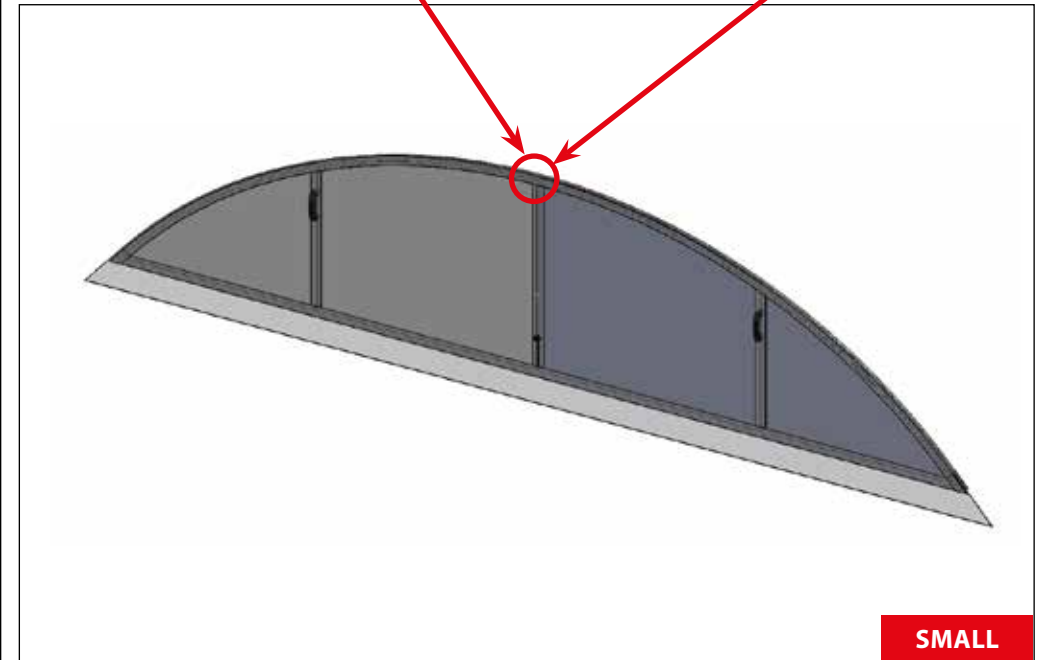
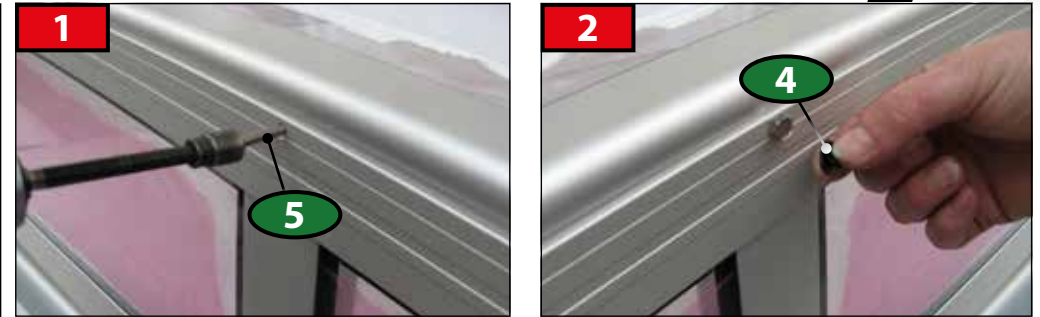
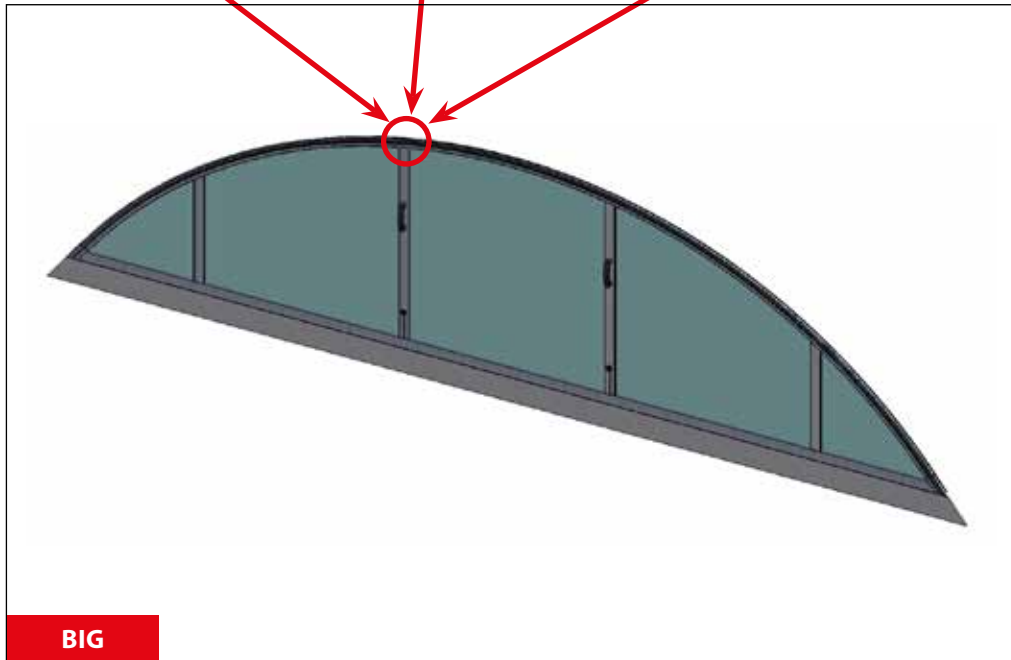

CZ

Dodavatel si vyhrazuje právo na změny a úpravy technických parametrů uváděných v tomto katalogu s ohledem na technický vývoj a zdokonalení výrobků a balení. Dodavatel si vyhrazuje právo na tiskové chyby a chyby v sazbě. Před montáží si pozorně přečtěte návod. Návod si uchovejte pro pozdější použití.

DE

Der Lieferant behält sich das Recht auf Änderungen und Anpassungen der technischen Parameter, die in diesem Katalog aufgeführt sind, mit Rücksicht auf die technische Entwicklung und Verbesserung der Produkte und Verpackung vor. Der Lieferant behält sich das Recht auf Druckfehler und Fehler im Satz vor. Vor der Montage lesen Sie bitte die Anleitung sorgfältig durch. Bewahren Sie die Anleitung für spätere Verwendung auf.

EN

The supplier reserves the right for modifications and adaptations of the technical parameters stated in this catalogue, considering the technical development and upgrade of the products and packaging. The supplier reserves the right for print errors and typographical errors. Please read the manual carefully before you will start the installation. Keep the manual for later use.

ES

El proveedor se reserva el derecho de hacer cambios y modificaciones técnicas de los parámetros que figuran en este catálogo, con respecto al desarrollo técnico mejorando los productos y embalajes. El proveedor se reserva también el derecho a errores de impresión y composición. Antes de empezar la instalación, lea atentamente las instrucciones. Guarde las instrucciones para su uso posterior.

FR

Le fabricant se réserve le droit de modifier les paramètres techniques cités dans ce manuel en considération du développement technique et de l'amélioration des produits et de leur emballage. Le fabricant se réserve le droit des fautes d'impression et de composition. À lire attentivement et à conserver pour une consultation ultérieure.

HU

Gyártó fenntartja jogát a katalógusban feltüntetett műszaki paraméterek változtatására a termékek és csomagolás technikai fejlesztése és tökéletesítése szerint. Szállító: a szállító fenntartja jogát a nyomtatási és szedési hibákra.

IT

Il fornitore si riserva il diritto di effettuare modifiche e correzioni ai parametri tecnici riportati nel presente catalogo per migliorare e perfezionare dal punto di vista tecnico i prodotti e gli imballaggi. Il fornitore non esclude inoltre l'eventuale presenza di errori di stampa e di impaginazione. Prima dell'installazione, leggere attentamente le istruzioni. Tenere l'istruzione per un uso successivo.

PL

Dostawca zastrzega sobie prawo do zmian oraz dostosowania parametrów technicznych podanych w niniejszym katalogu z uwzględnieniem rozwoju technicznego i udoskonalania produktów oraz opakowań. Dostawca zastrzega sobie prawo do błędów druku oraz typograficznych.

PT

O provedor reserva-se o direito a efectuar alterações e adaptações de parâmetros técnicos mencionados neste catálogo, tendo em consideração o avanço técnico e melhorias de produtos e embalagens. O provedor reserva-se o direito a cometer erros de impressora e de edição.

RO

Furnizorul își rezervă dreptul de a modifica și schimba parametrii tehnici menționați în acest catalog cu privire la evoluția tehnică și perfecționarea produselor și a ambalării. Furnizorul își rezervă dreptul la greșelile de tipar și greșelile privind tarifele.

RU

Поставщик оставляет за собой право на изменение и исправление технических параметров продукции указанной в этом каталоге, с учетом технического развития, а усовершенствования изделий и его упаковки. Поставщик оставляет за собой право на опечатку в тексте и в ценах. Перед установкой и эксплуатацией изделия внимательно ознакомьтесь с настоящим руководством. Сохраните данное руководство для дальнейшего использования.