

# KLASIK A 2017

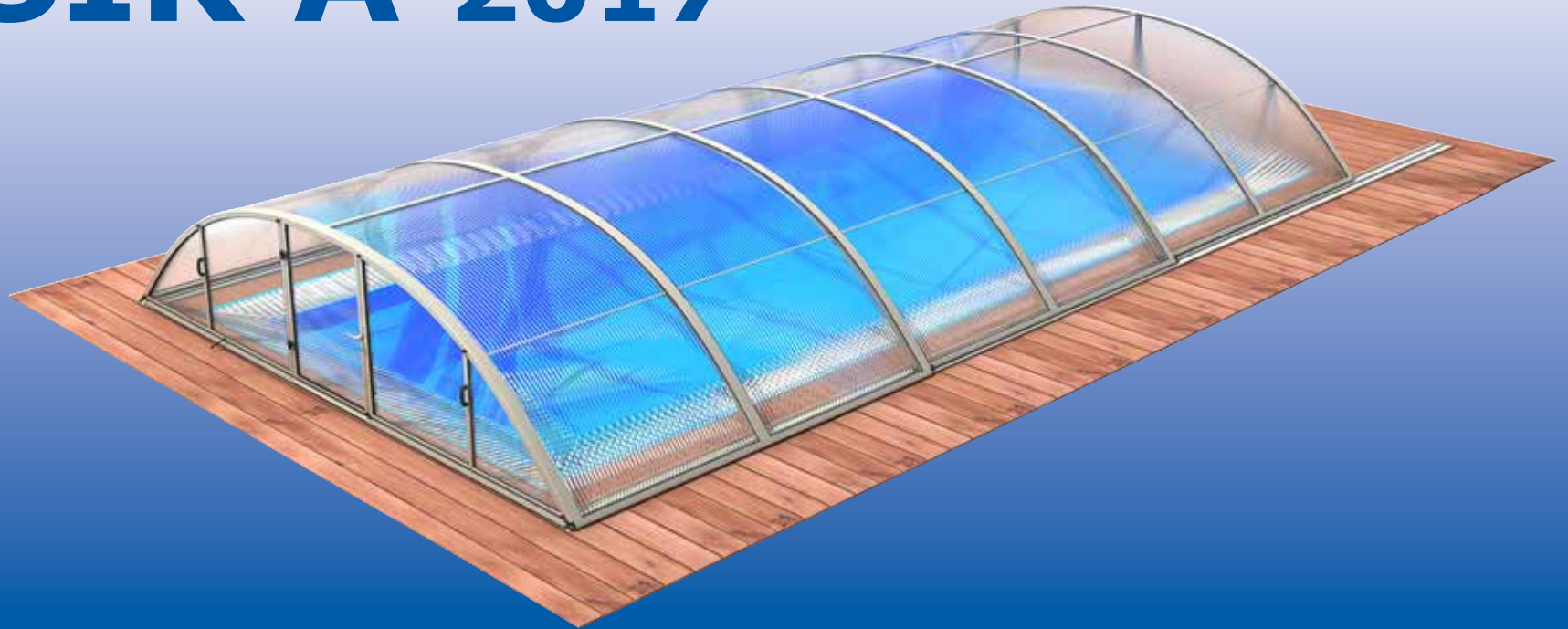

VERZE: 5. 10. 2017 / REVIZE: 5. 10. 2017

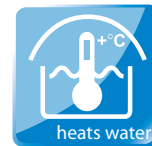

**BG**  
 Тръгващ да Съобразява: не е необходимо  
 За повече информация: АНЧДК - № F 90-300  
 За повече информация: АНЧДК - № F 90-300  
 За повече информация: АНЧДК - № F 90-300

**DE**  
 Schwimmplatzüberbauung: keine Konstruktion  
 Einbauzeit: ca. 10-15 Tage  
 Einbauzeit: ca. 10-15 Tage  
 Einbauzeit: ca. 10-15 Tage

**ES**  
 Cubierta de piscina: no es necesario  
 Construcción: 10-15 días  
 Construcción: 10-15 días  
 Construcción: 10-15 días

**FR**  
 Hors de piscine: pas de construction  
 Construction: 10-15 jours  
 Construction: 10-15 jours  
 Construction: 10-15 jours

**HU**  
 Működés közben: nincs szükség  
 Alkalmazás: 10-15 nap  
 Alkalmazás: 10-15 nap  
 Alkalmazás: 10-15 nap

**CN**  
 无需建造: 不需要  
 建造时间: 10-15天  
 建造时间: 10-15天  
 建造时间: 10-15天

**LT**  
 Nerečių vietos apšildymui: nėra reikalingas  
 Statybos laikas: 10-15 dienas  
 Statybos laikas: 10-15 dienas  
 Statybos laikas: 10-15 dienas

**PL**  
 Zakładzenie basenu: nie ma konstrukcji  
 Czas budowy: 10-15 dni  
 Czas budowy: 10-15 dni  
 Czas budowy: 10-15 dni

**RU**  
 Установка: не требуется  
 Срок установки: 10-15 дней  
 Срок установки: 10-15 дней  
 Срок установки: 10-15 дней

**SL**  
 Nadziranje: ni potrebno  
 Čas gradnje: 10-15 dni  
 Čas gradnje: 10-15 dni  
 Čas gradnje: 10-15 dni

**CZ**  
 Instalace: není třeba  
 Doba instalace: 10-15 dní  
 Doba instalace: 10-15 dní  
 Doba instalace: 10-15 dní

**DK**  
 Bænkoverdækning: ikke nødvendig  
 Anvendelsestid: 10-15 dage  
 Anvendelsestid: 10-15 dage  
 Anvendelsestid: 10-15 dage

**EE**  
 Kõrvaldamine: ei ole vaja  
 Paigaldamine: 10-15 päeva  
 Paigaldamine: 10-15 päeva  
 Paigaldamine: 10-15 päeva

**GB**  
 The swimming pool enclosure: not required  
 Installation time: 10-15 days  
 Installation time: 10-15 days  
 Installation time: 10-15 days

**HR**  
 Nadziranje: nije potrebno  
 Vrijeme instalacije: 10-15 dana  
 Vrijeme instalacije: 10-15 dana  
 Vrijeme instalacije: 10-15 dana



**IT**  
 Copertura per piscine: non è necessaria  
 Tempo di installazione: 10-15 giorni  
 Tempo di installazione: 10-15 giorni  
 Tempo di installazione: 10-15 giorni

**LV**  
 Bāvētne: nav nepieciešama  
 Instalācijas laiks: 10-15 dienas  
 Instalācijas laiks: 10-15 dienas  
 Instalācijas laiks: 10-15 dienas

**RO**  
 Acoperișul pentru piscină: nu este necesar  
 Durata de instalare: 10-15 zile  
 Durata de instalare: 10-15 zile  
 Durata de instalare: 10-15 zile

**SE**  
 Pooltak: inte konstruktion  
 Installeringstid: 10-15 dagar  
 Installeringstid: 10-15 dagar  
 Installeringstid: 10-15 dagar

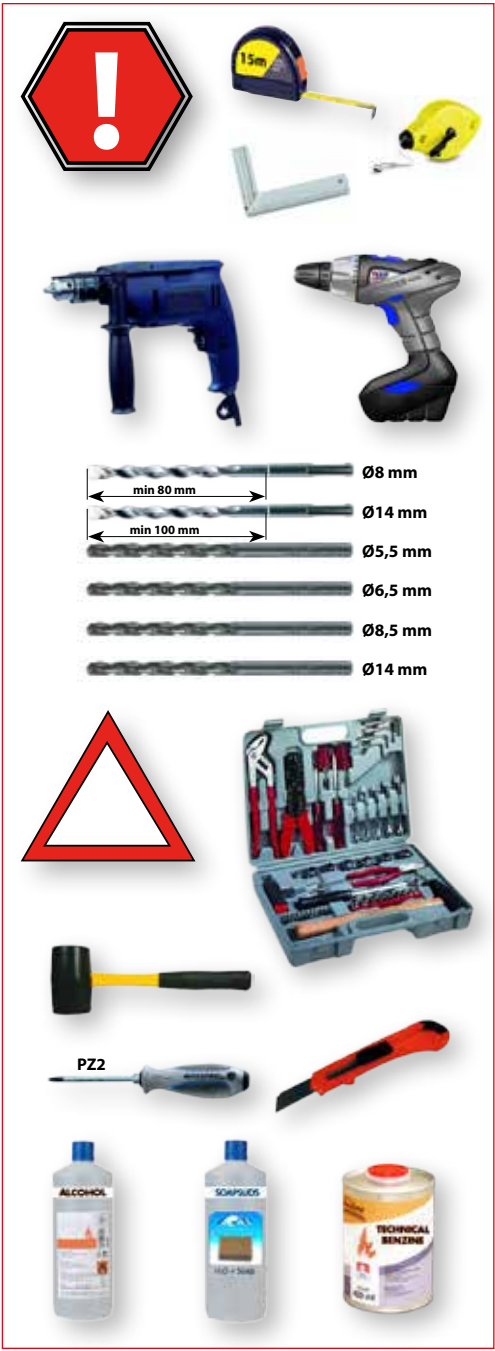
**SK**  
 Nadziranje: ni potrebno  
 Čas inštalácie: 10-15 dní  
 Čas inštalácie: 10-15 dní  
 Čas inštalácie: 10-15 dní

DIN 7982  
4,8 x 13  
16x  
**1**



650.01.8811.2  
12x  
**2**

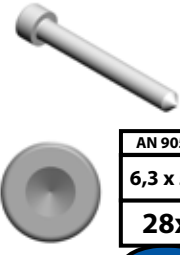

AN 9051  
6,3 x 50  
28x  
**3**



007.20.1501.2  
4x  
**4**



DIN 7976  
6,3 x 38  
4x  
**5**



650.01.0021.2  
4x  
**6**



007.02.0030.2  
ø4 x 10  
36x  
**7**



007.20.1605.2  
1x  
**8**



007.10.7012.2  
ø8 x 80  
48x  
**9**



007.90.7022.2  
1x  
**10**



007.02.0092.2  
ø4 x 14  
4x  
**11**



007.90.4505.2  
4x  
**12**

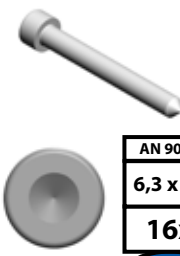

AN 9051  
6,3 x 38  
16x  
**13**



ø4,2  
1x  
**14**



SILICONE  
1x  
**15**



1x  
**16**



1x  
**17**



1x  
**18**



097.02.0040.2  
2x  
**19**



097.02.0041.2  
2x  
**20**

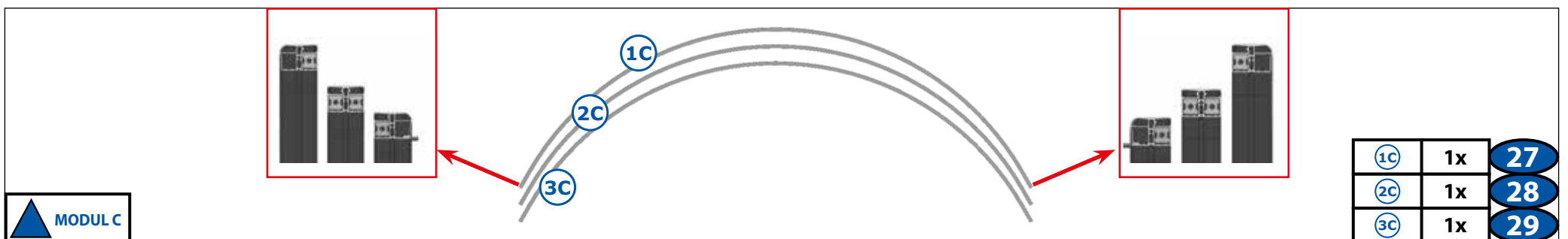
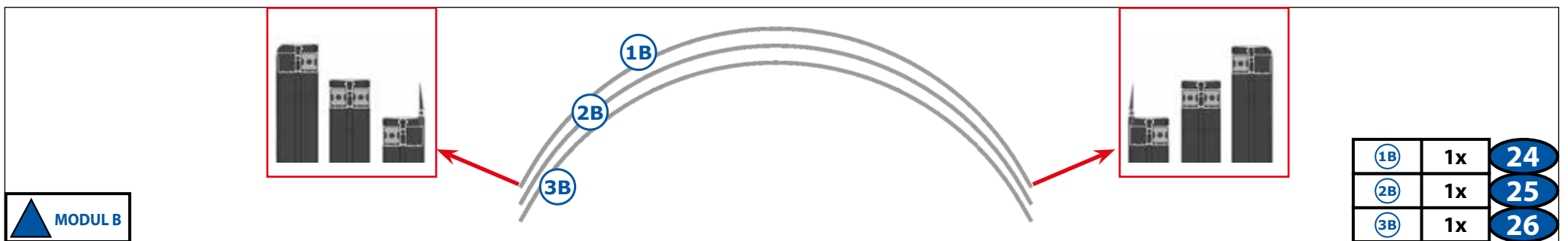
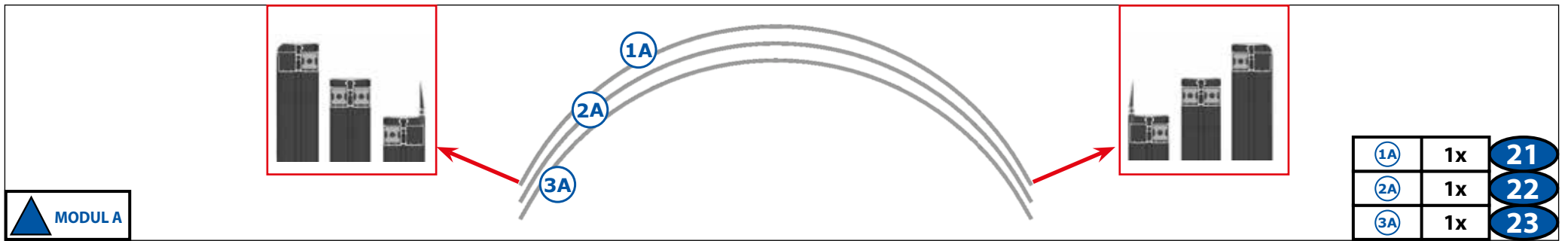
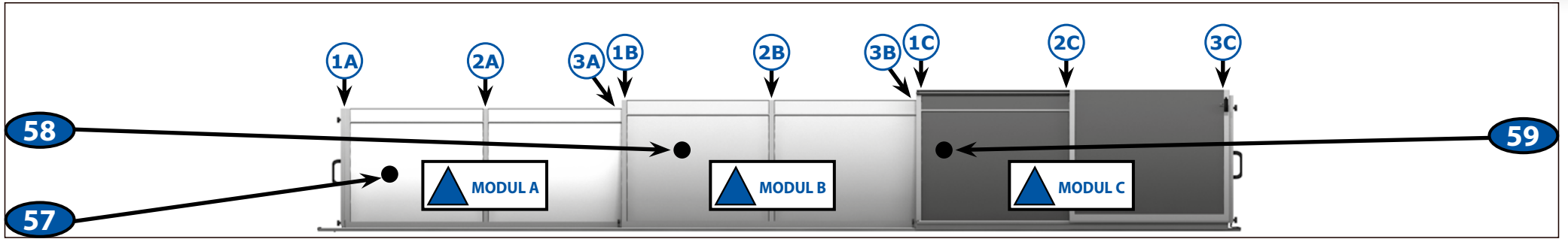



1041 mm
16x
<b>36</b>

<b>A</b>
3230 mm
2x
<b>40</b>

<b>D</b>
3230 mm
2x
<b>46</b>

3230 mm  
12x  
**48**

**MODUL C**

1x  
**50**

**MODUL C**

1x  
**51**

**MODUL B**

1x  
**52**

**MODUL B**

1x  
**53**

**MODUL A**

1x  
**54**

**MODUL A**

1x  
**55**





OUT

MODUL A

MODUL A

2x

3817 x 1049 mm

**57**

OUT

MODUL B

MODUL B

2x

4005 x 1049 mm

**58**

OUT

MODUL C

MODUL C

MODUL C

3x

2093 x 1049 mm

**59**

OUT

MODUL

1x

2045 x 1049 mm

**60**

1x

**61**

1x

**62**

ALBIXON

ALBIXON a.s.  
Zbraslavská 55  
Praha 5 - Malá Chuchle  
159 00

KLASIK

1x

**63**



1x  
**69**

1x  
**70**

2150 mm  
1x  
**71**

2150 mm  
1x  
**72**



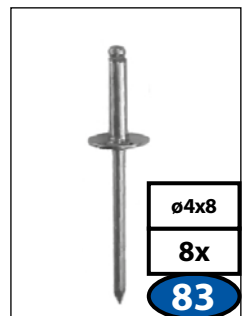
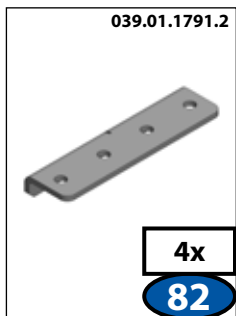
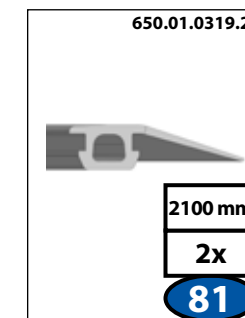
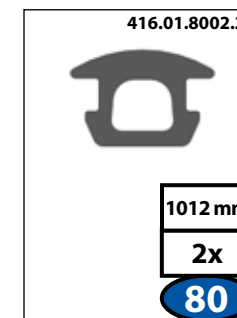
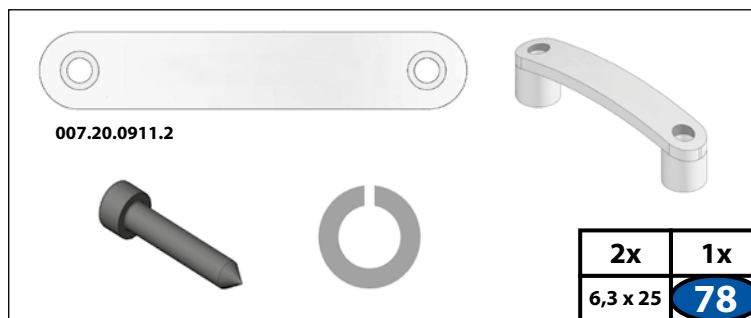
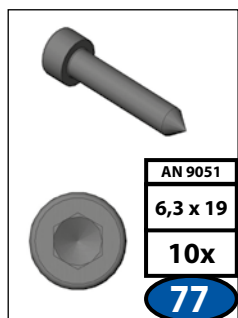
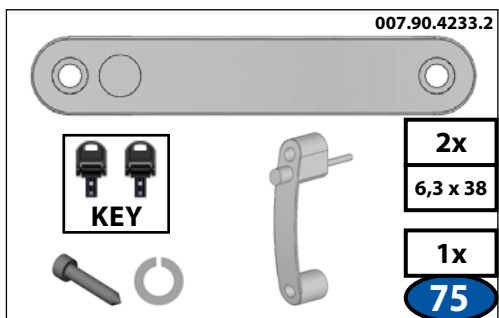
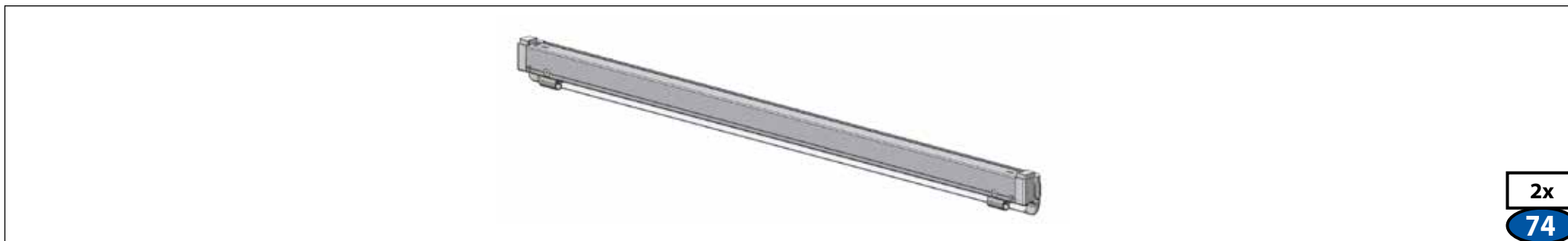
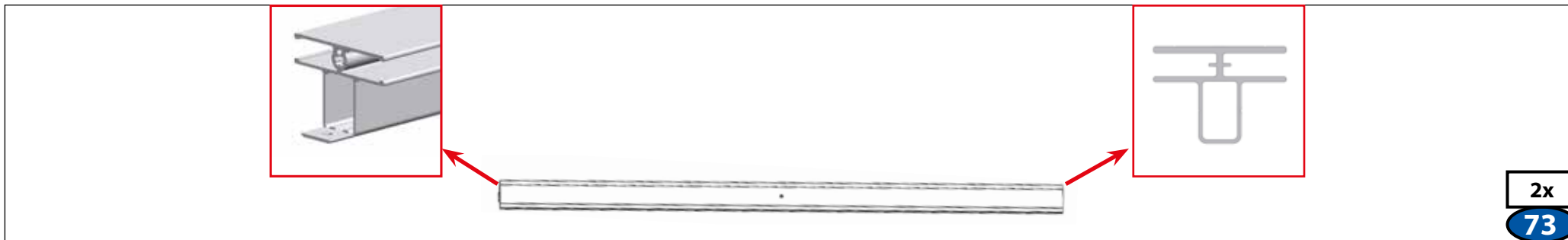

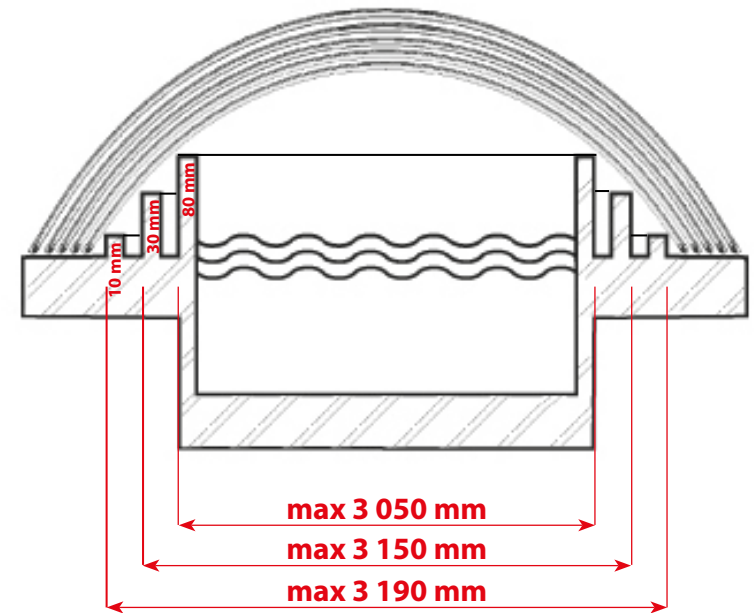
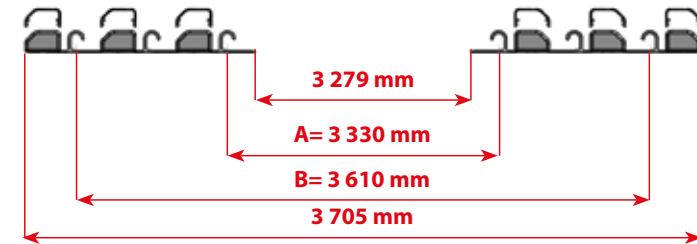
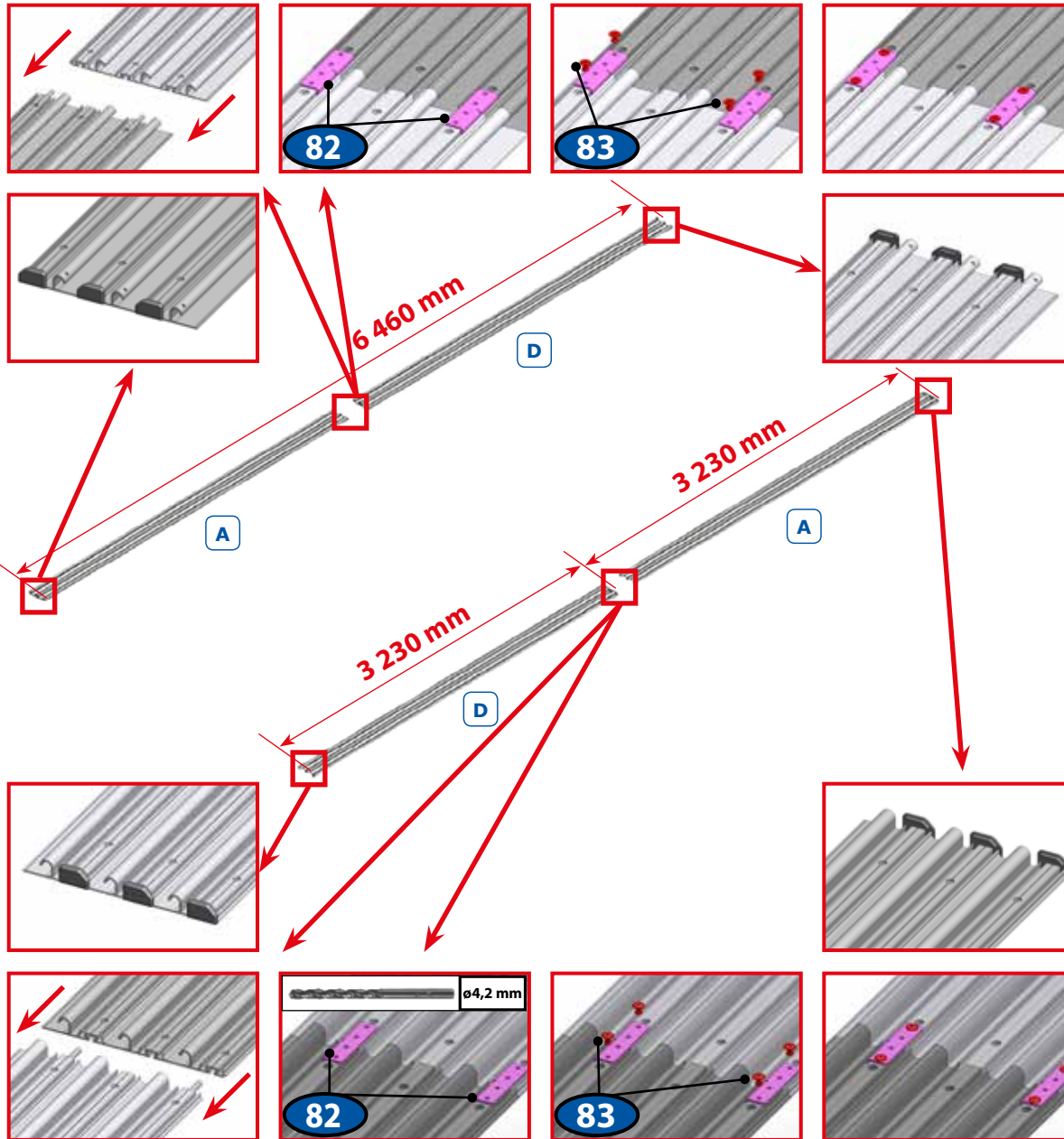

2x	<b>41</b>
2x	<b>47</b>

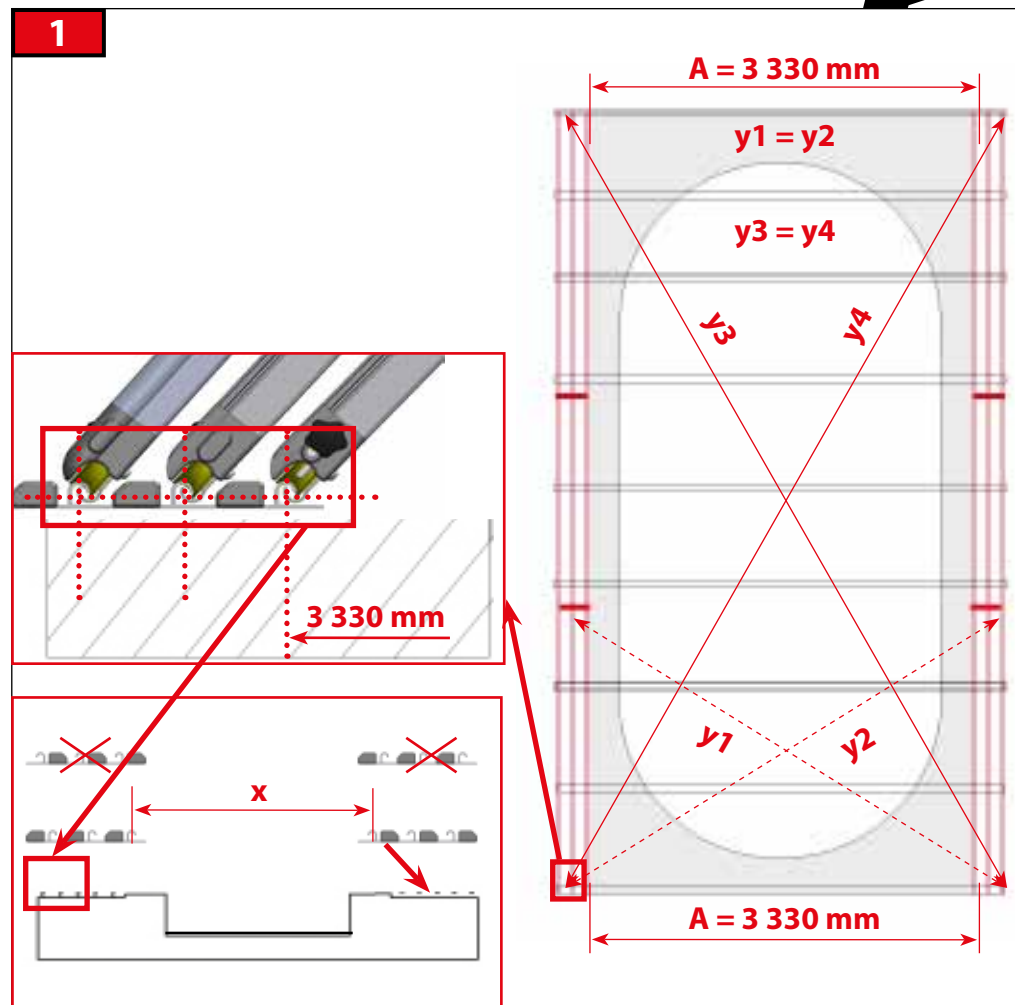
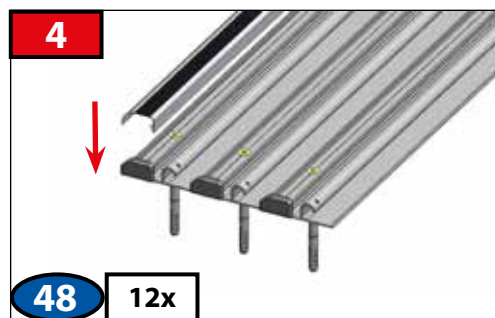
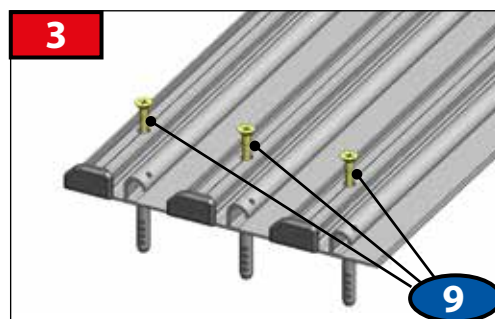
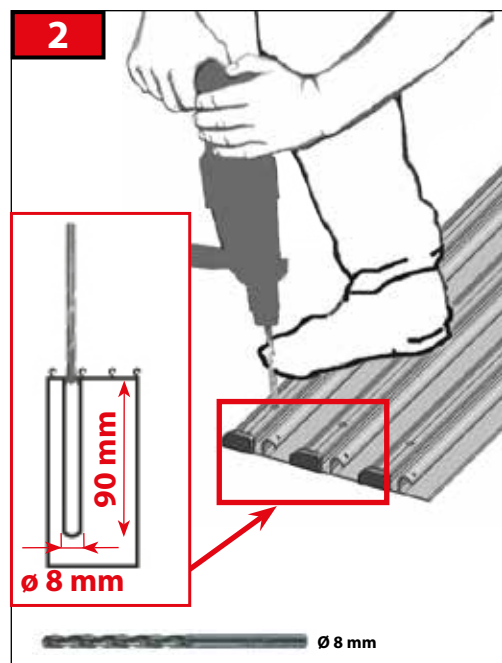
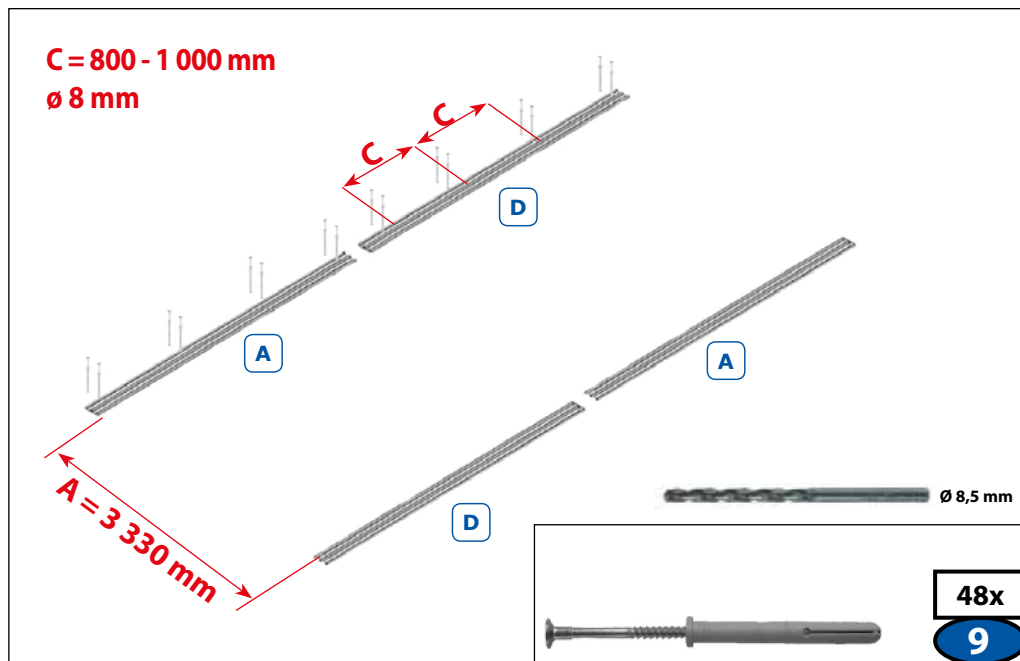





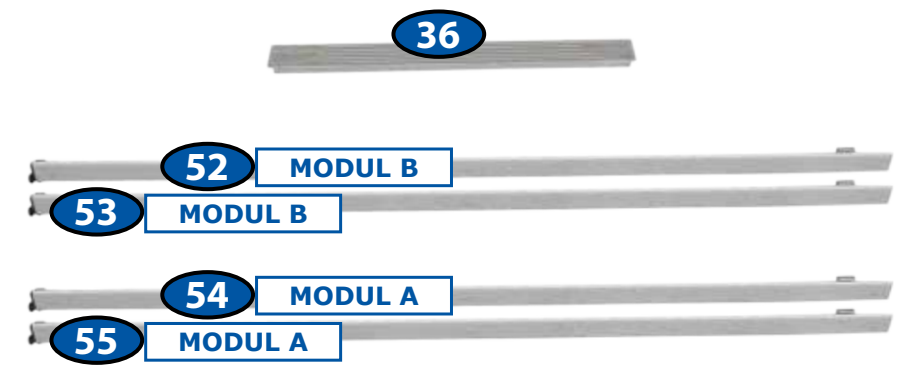
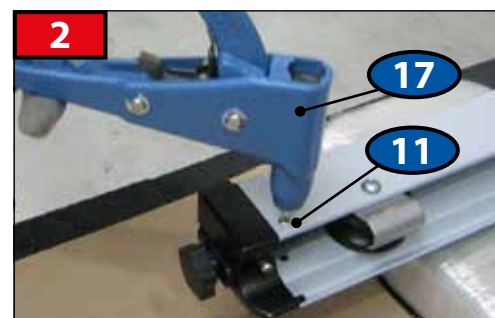
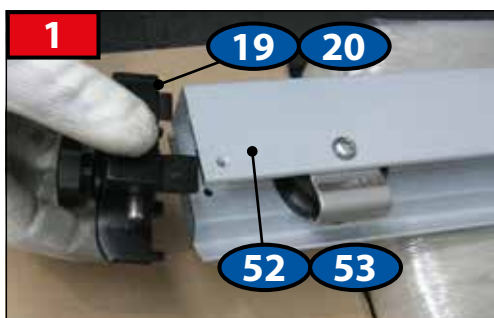
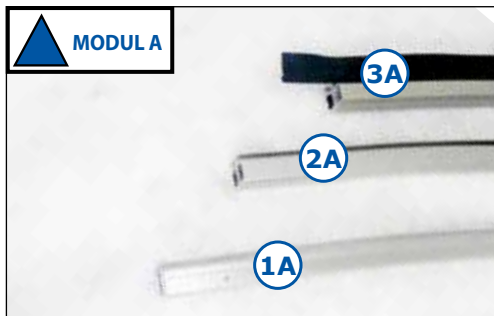
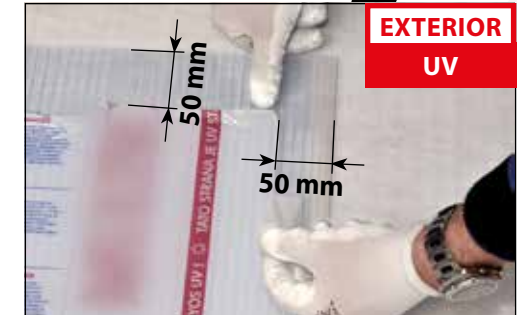

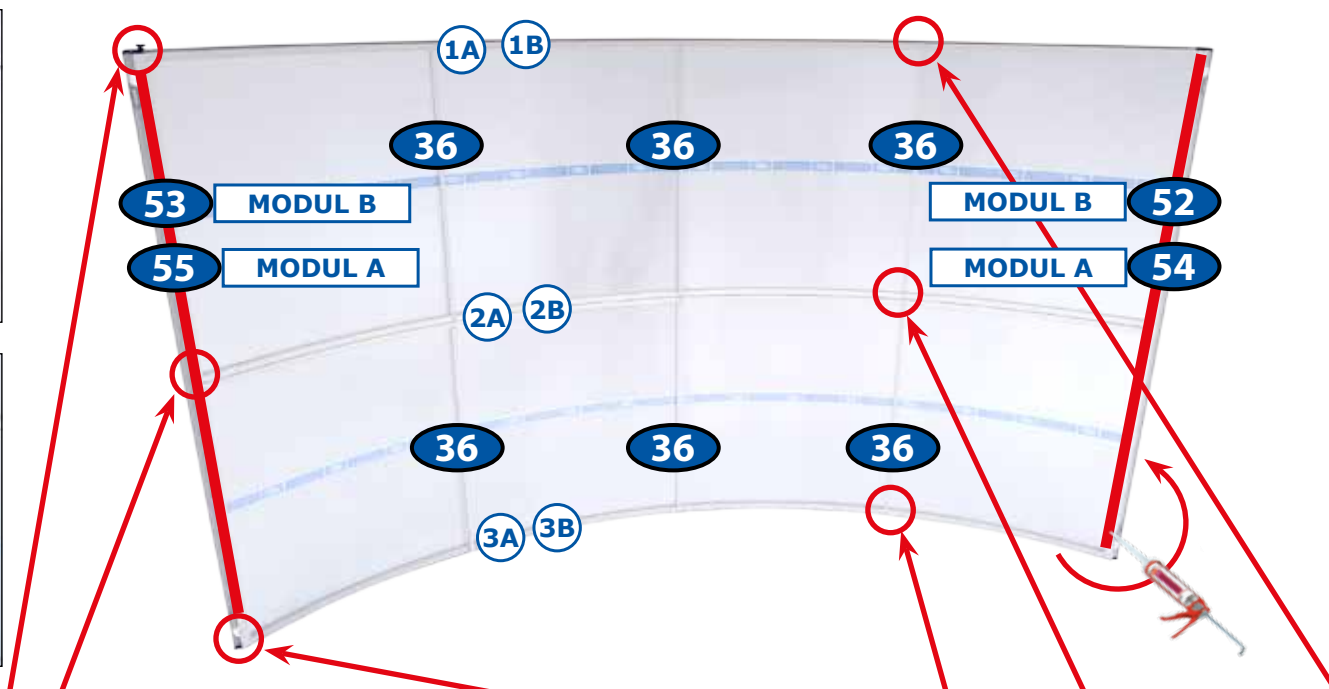
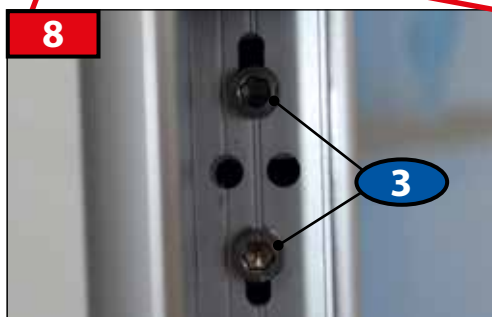
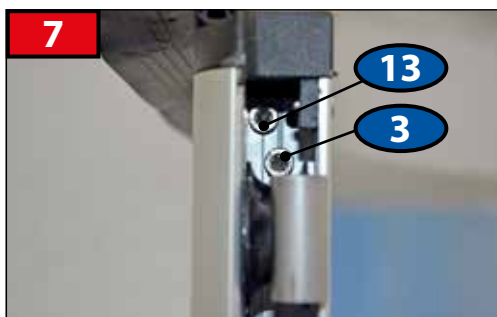
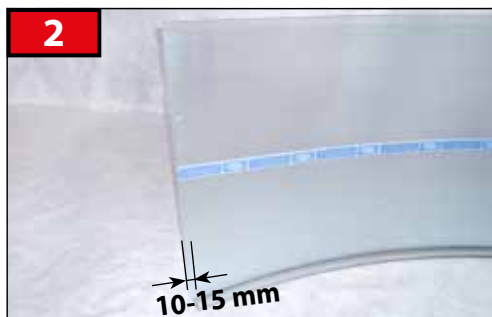



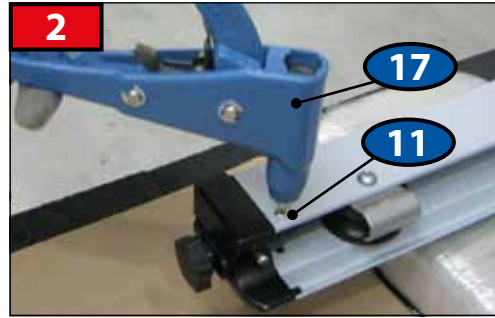
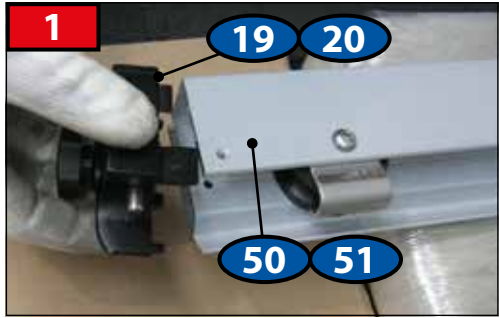
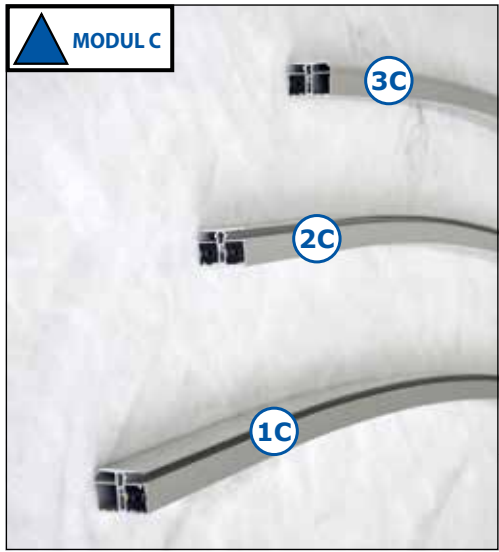
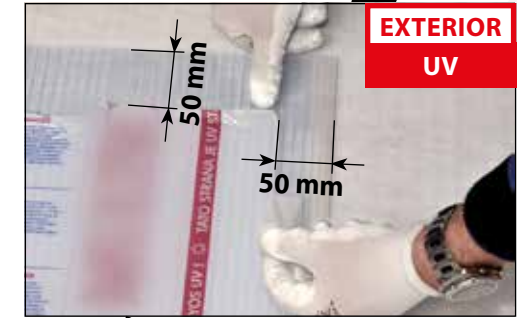
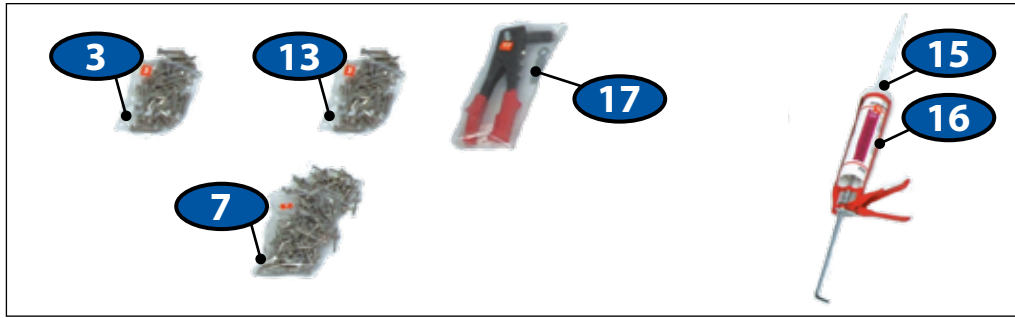



### DOOR LEFT

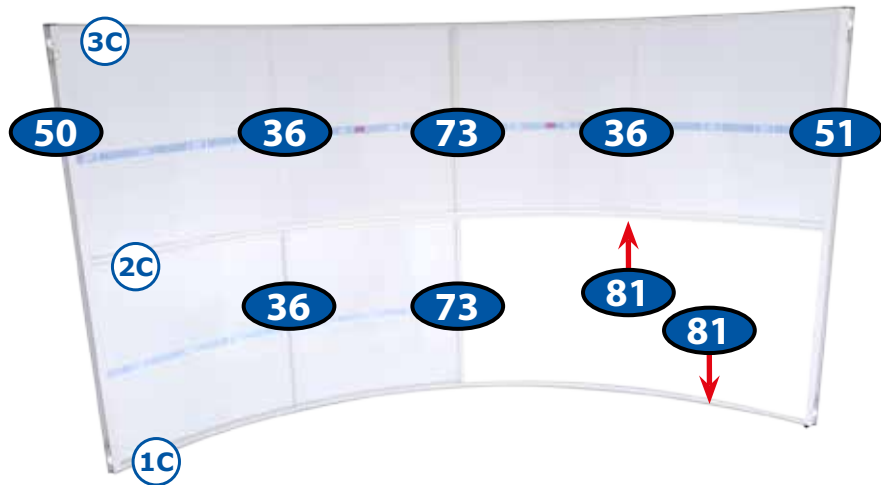
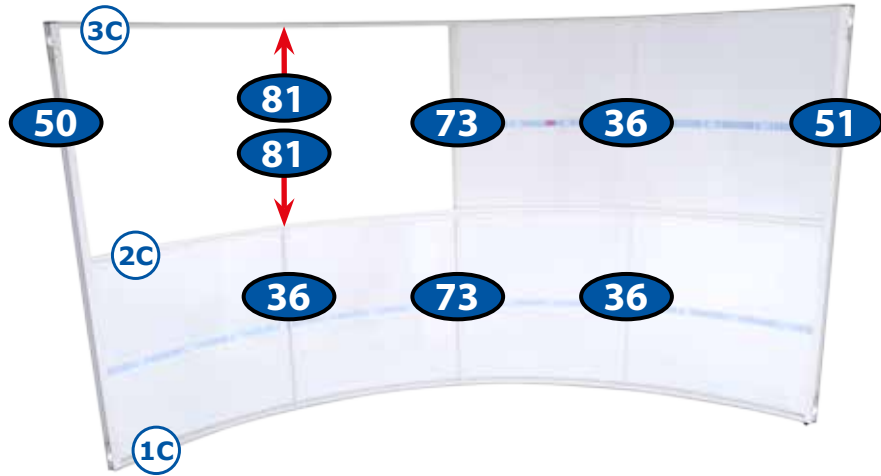

### DOOR RIGHT

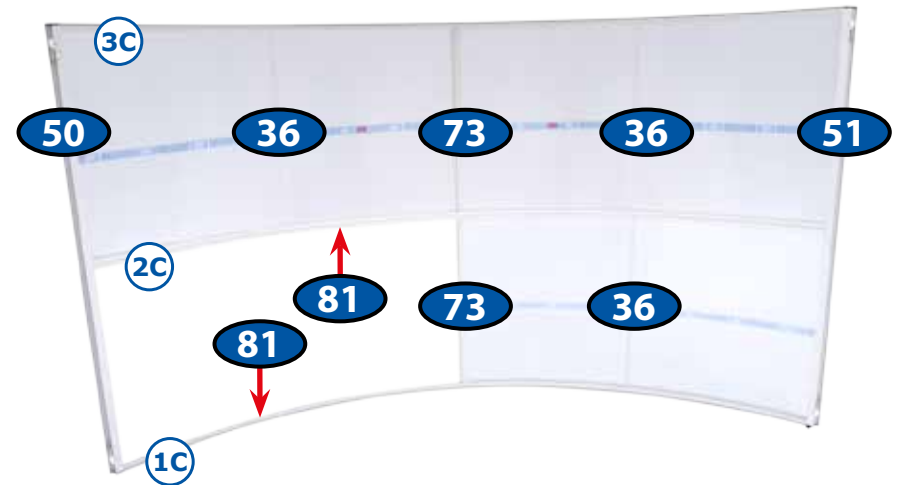
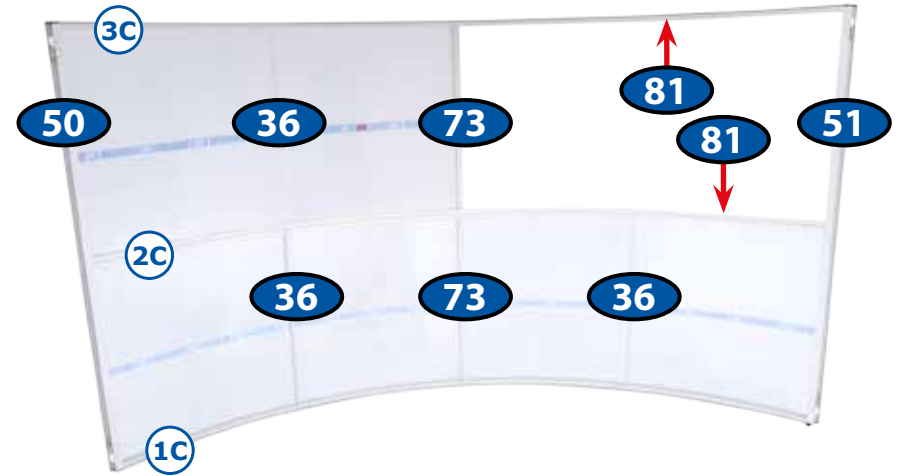

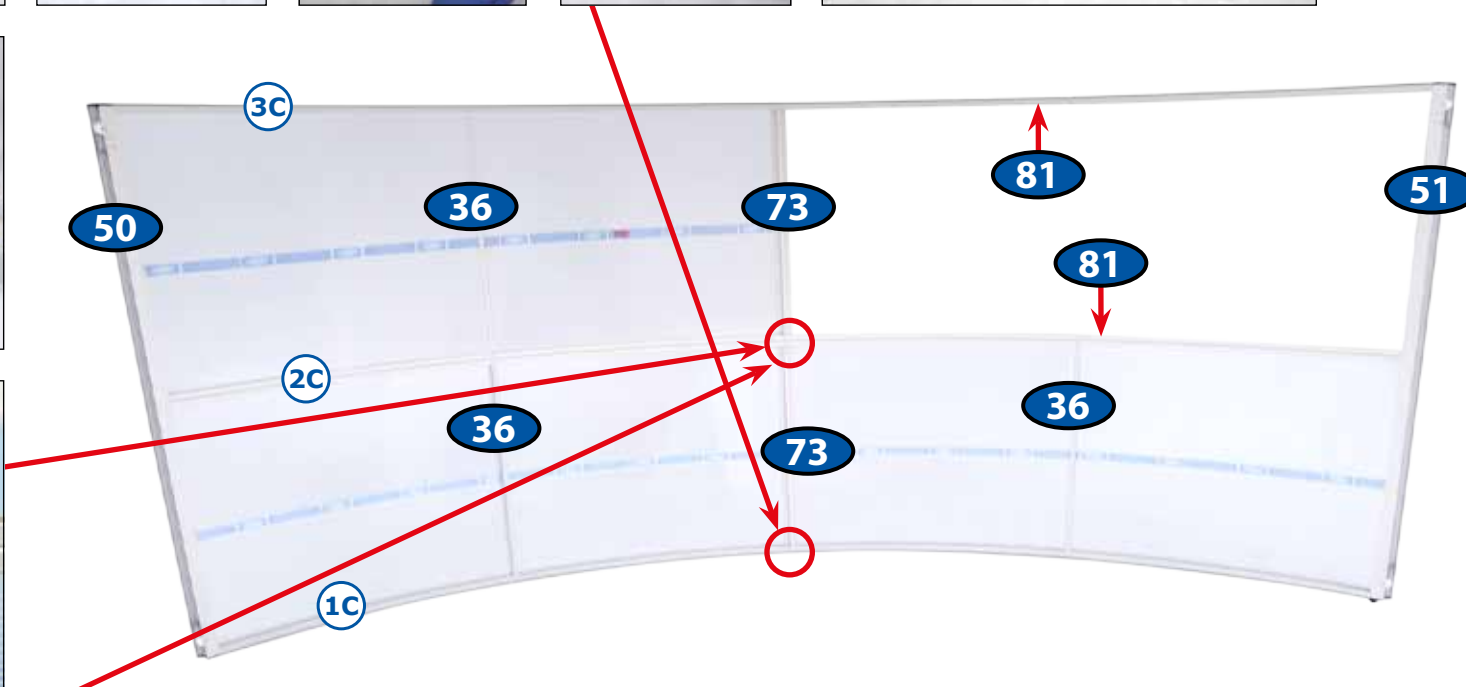

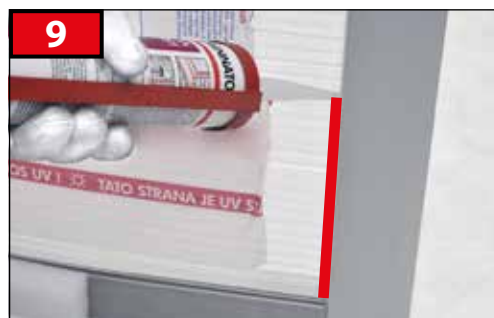
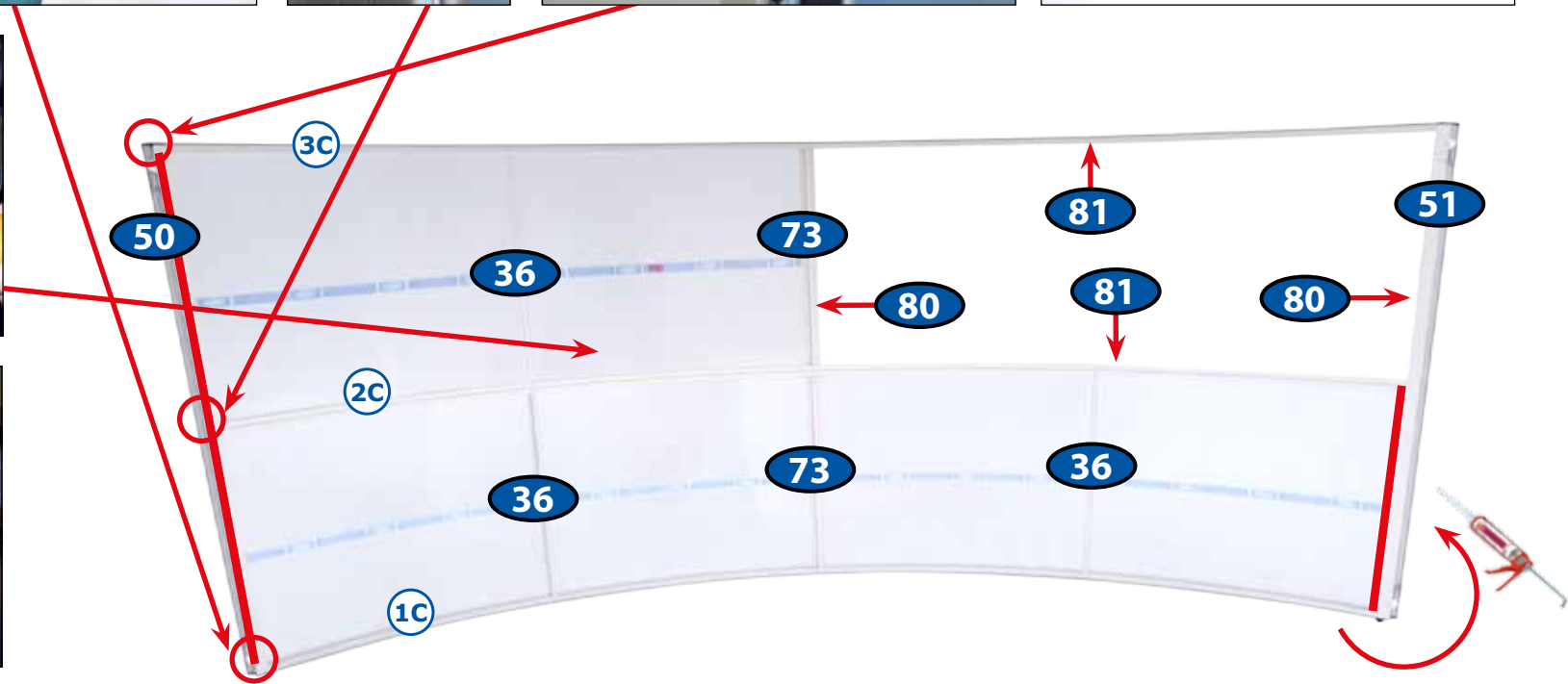
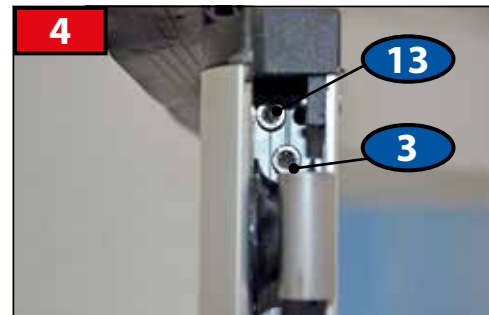



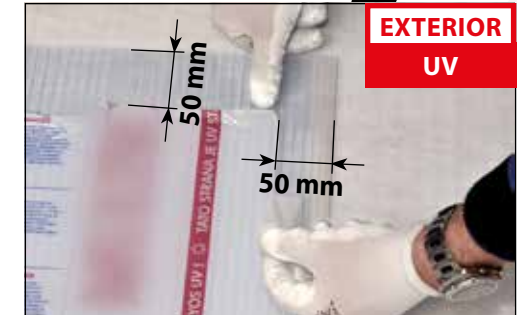
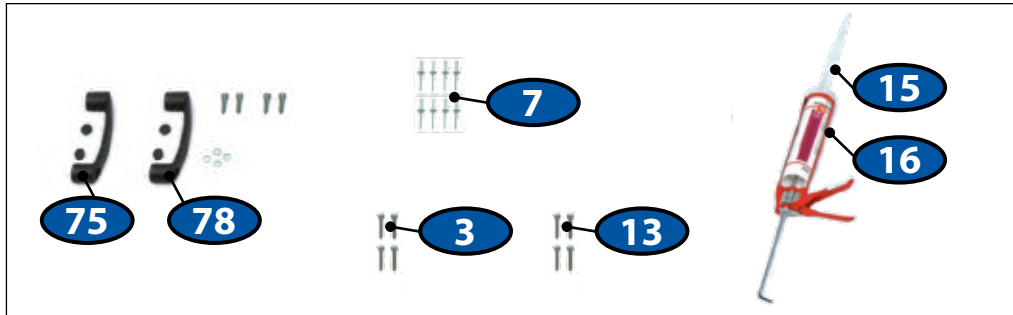

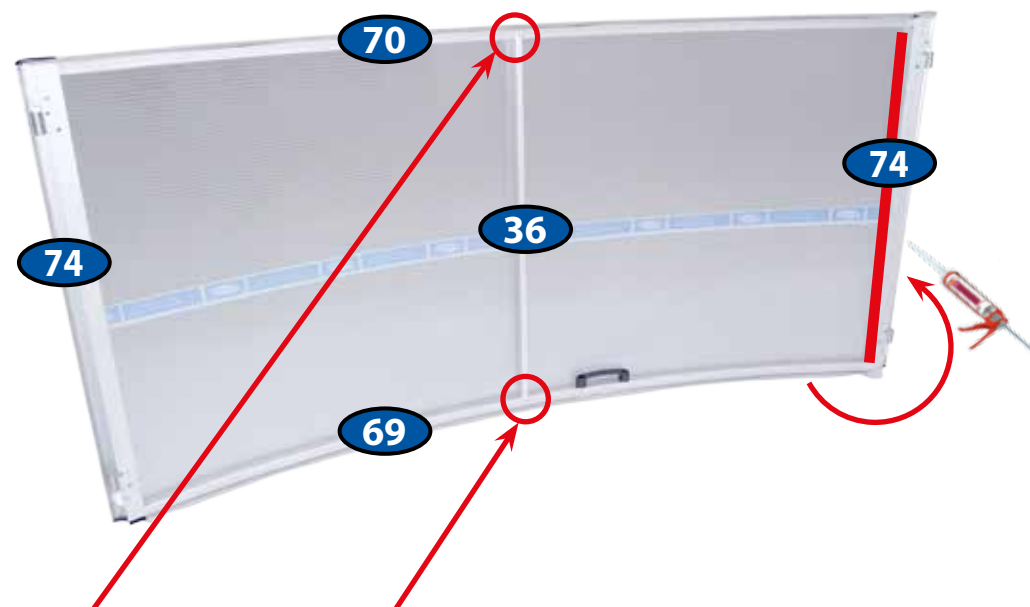



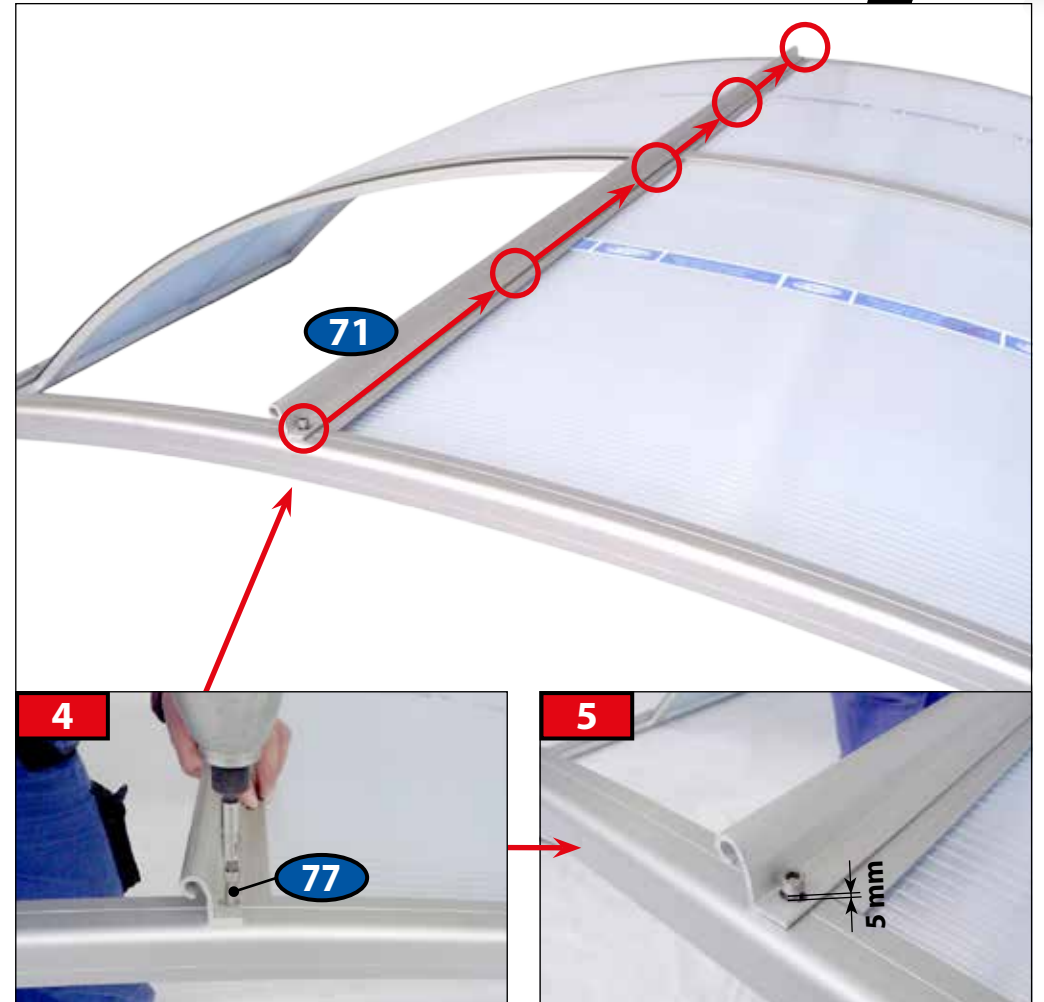

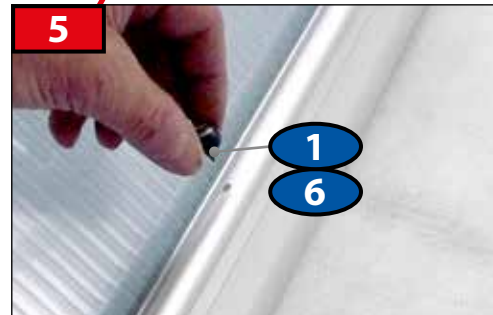
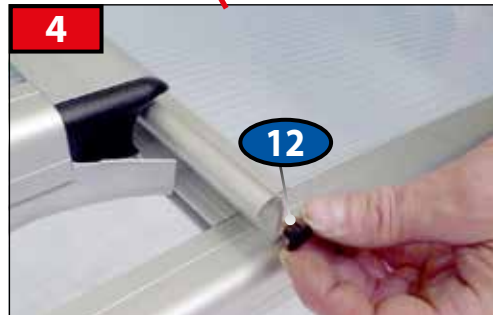
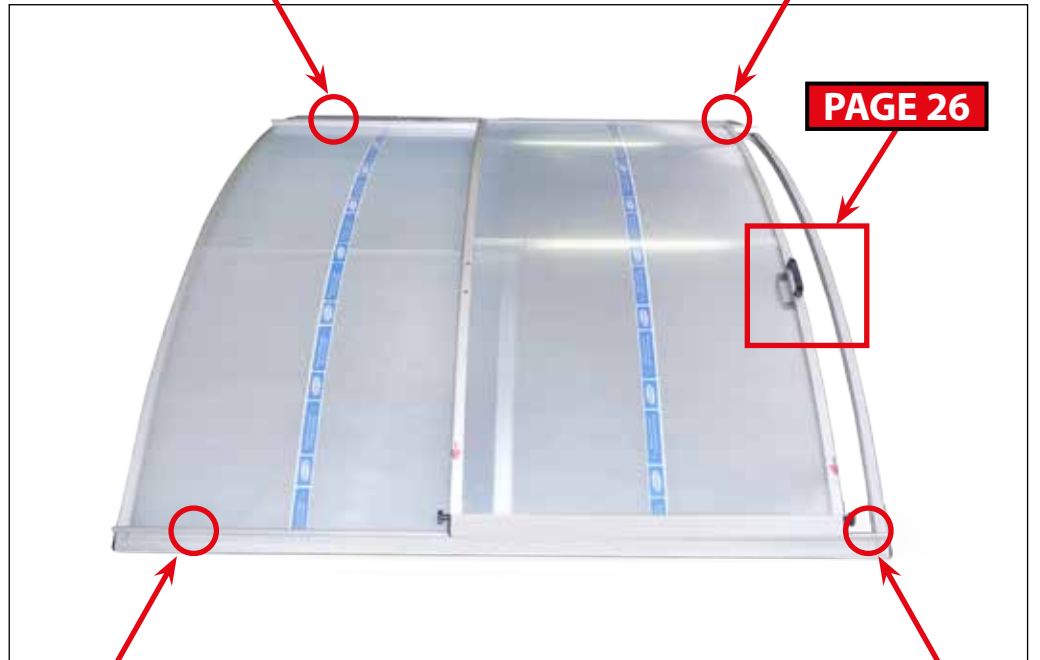
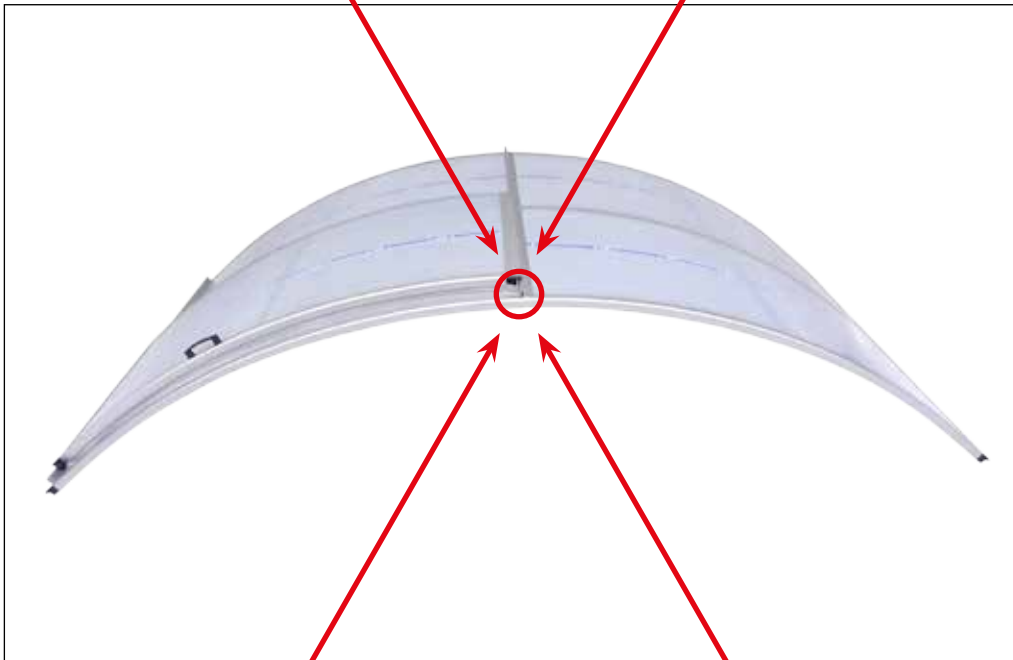
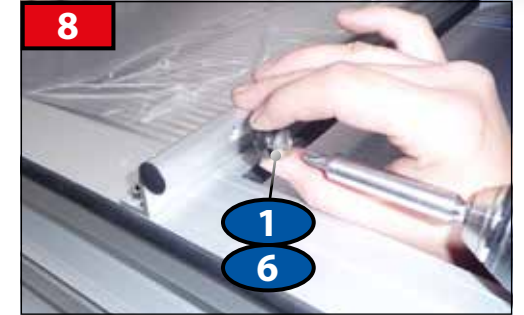

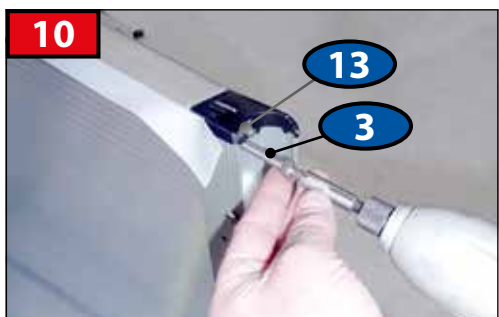
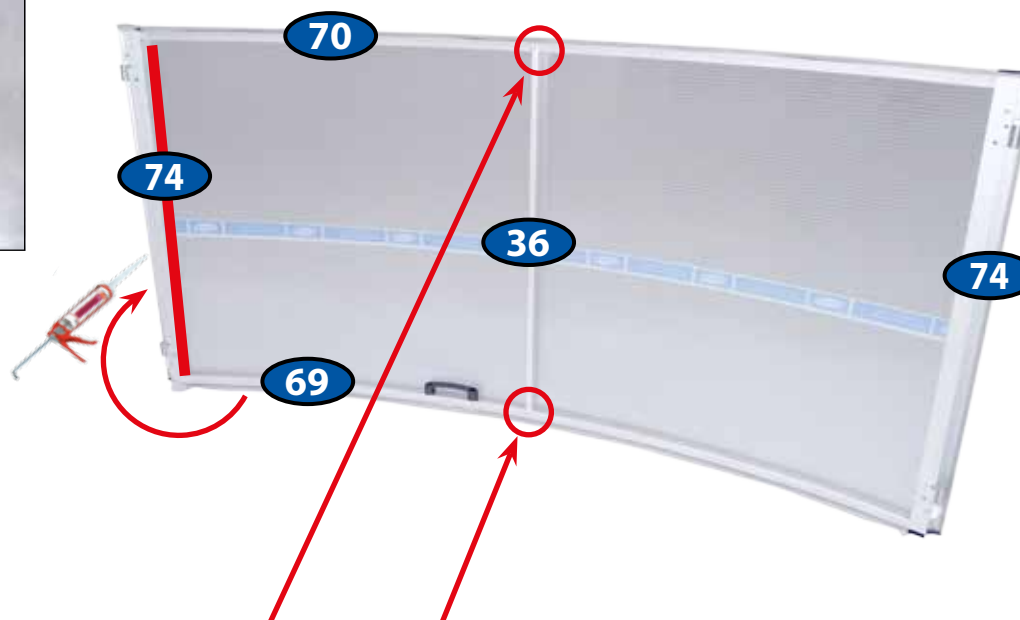





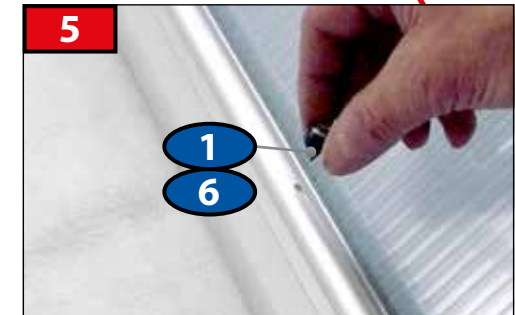
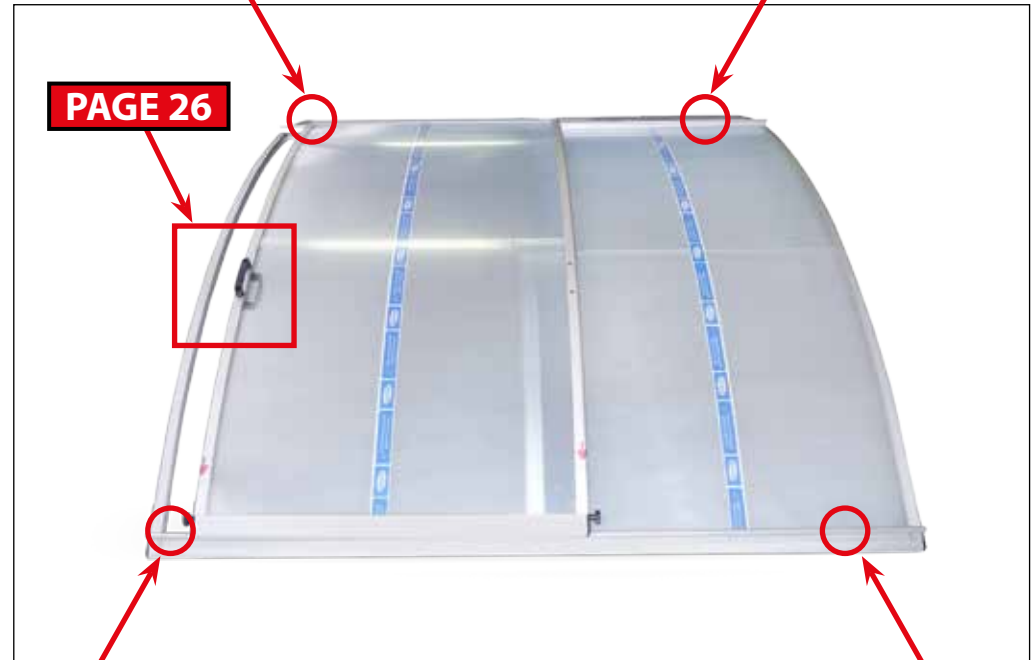
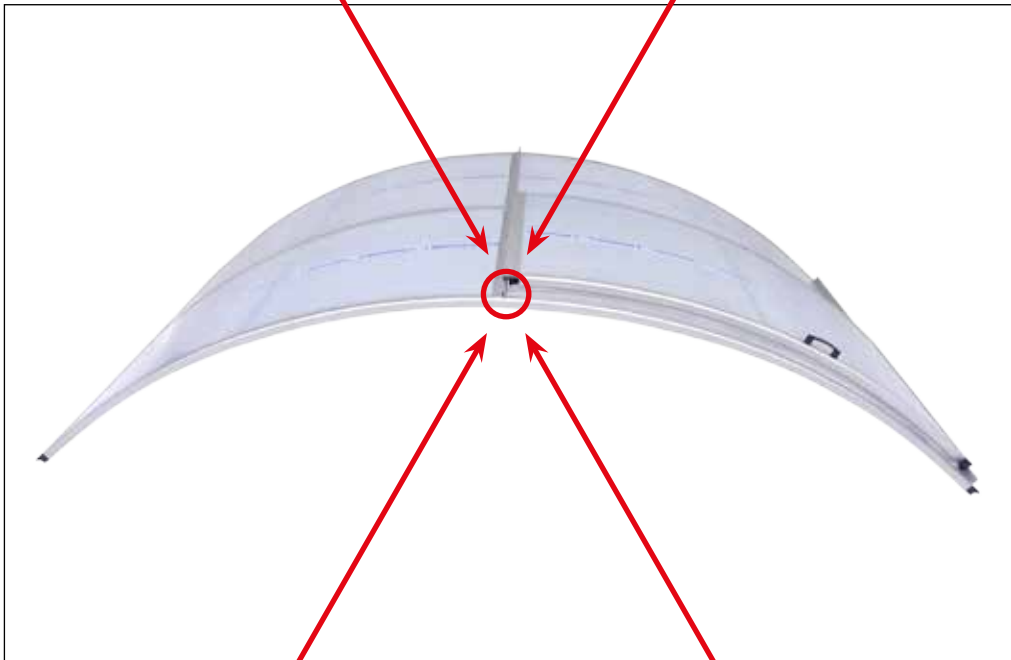
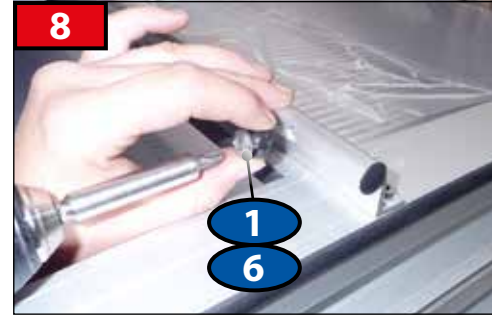

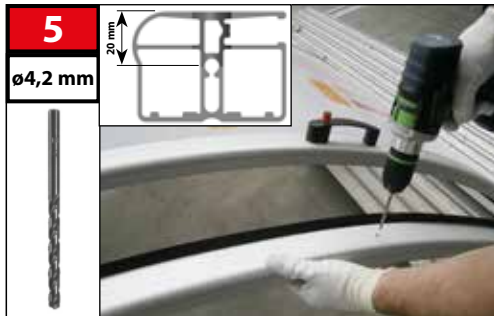



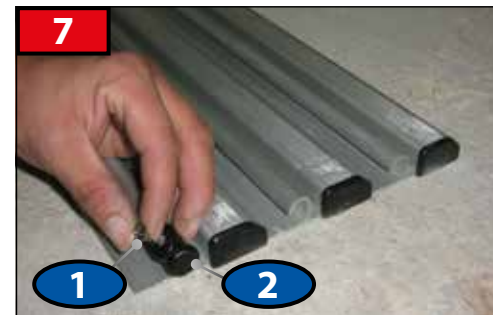
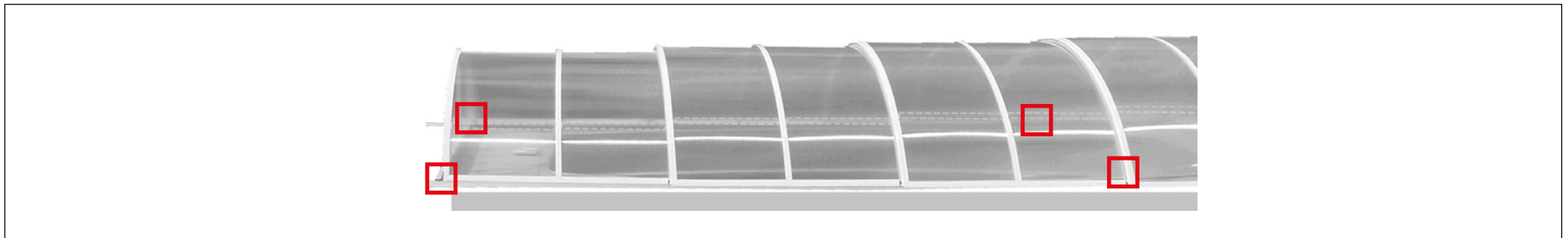
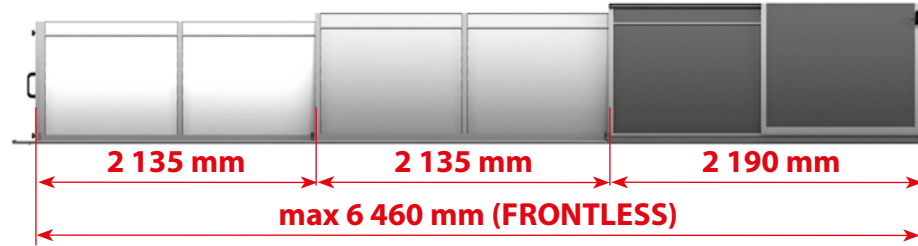

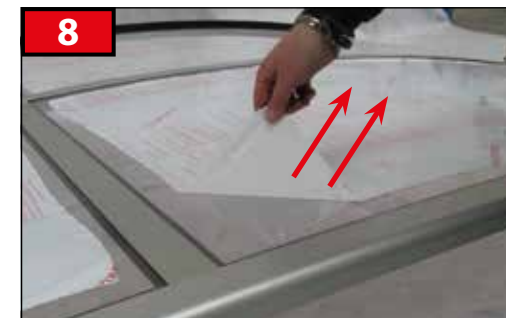
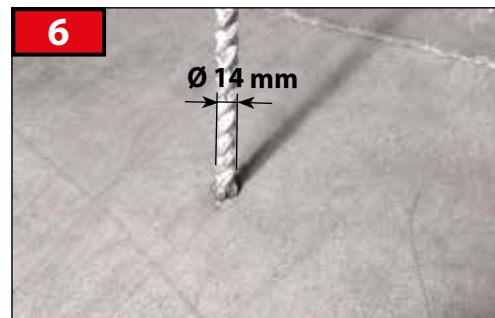
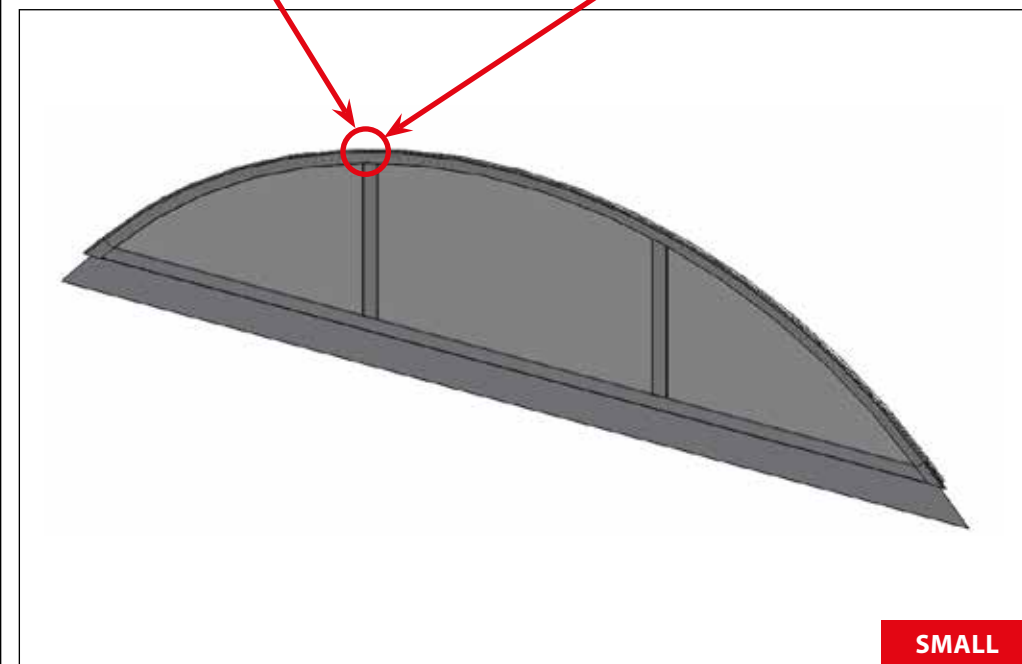
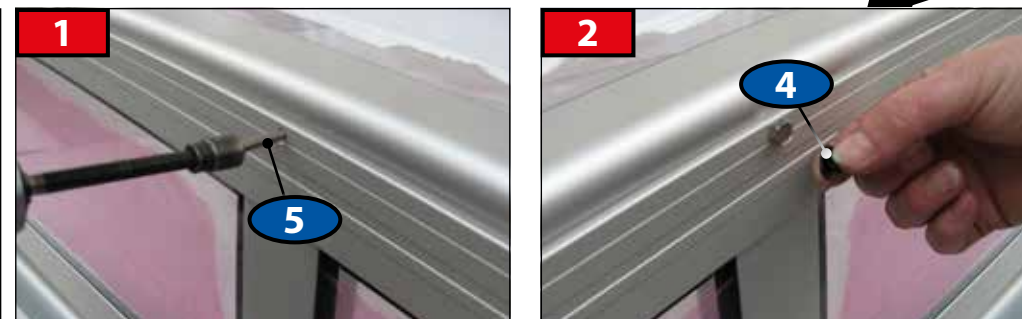
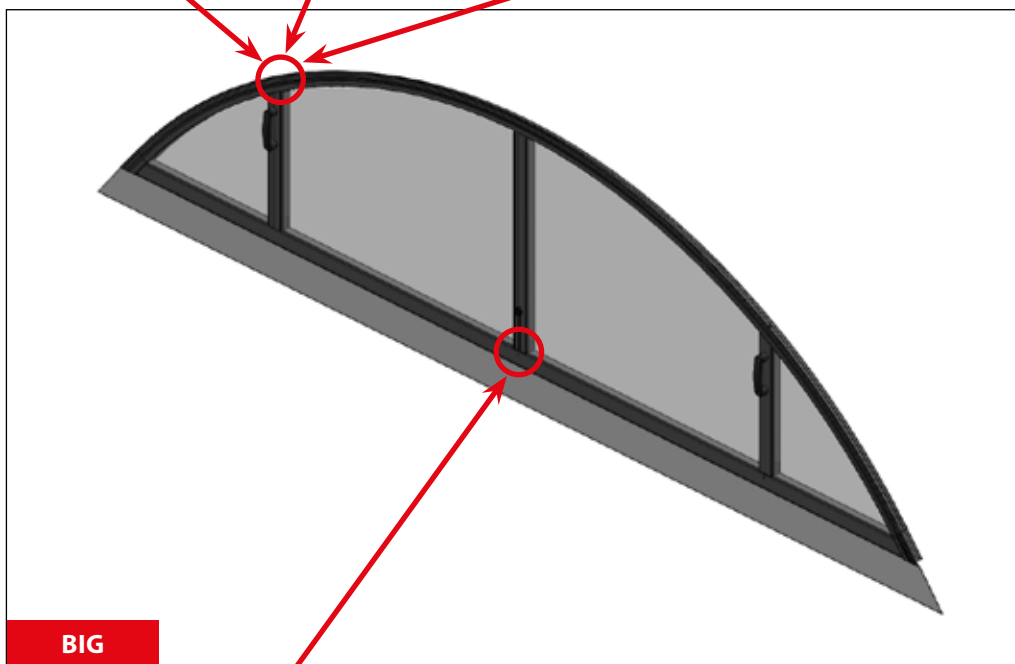

## **CZ**

Dodavatel si vyhrazuje právo na změny a úpravy technických parametrů uváděných v tomto katalogu s ohledem na technický vývoj a zdokonalení výrobků a balení. Dodavatel si vyhrazuje právo na tiskové chyby a chyby v sazbě. Před montáží si pozorně přečtěte návod. Návod si uchovejte pro pozdější použití.

## **DE**

Der Lieferant behält sich das Recht auf Änderungen und Anpassungen der technischen Parameter, die in diesem Katalog aufgeführt sind, mit Rücksicht auf die technische Entwicklung und Verbesserung der Produkte und Verpackung vor. Der Lieferant behält sich das Recht auf Druckfehler und Fehler im Satz vor. Vor der Montage lesen Sie bitte die Anleitung sorgfältig durch. Bewahren Sie die Anleitung für spätere Verwendung auf.

## **EN**

The supplier reserves the right for modifications and adaptations of the technical parameters stated in this catalogue, considering the technical development and upgrade of the products and packaging. The supplier reserves the right for print errors and typographical errors. Please read the manual carefully before you will start the installation. Keep the manual for later use.

## **ES**

El proveedor se reserva el derecho de hacer cambios y modificaciones técnicas de los parámetros que figuran en este catálogo, con respecto al desarrollo técnico mejorando los productos y embalajes. El proveedor se reserva también el derecho a errores de impresión y composición. Antes de empezar la instalación, lea atentamente las instrucciones. Guarde las instrucciones para su uso posterior.

## **FR**

Le fabricant se réserve le droit de modifier les paramètres techniques cités dans ce manuel en considération du développement technique et de l'amélioration des produits et de leur emballage. Le fabricant se réserve le droit des fautes d'impression et de composition. À lire attentivement et à conserver pour une consultation ultérieure.

## **HU**

Gyártó fenntartja jogát a katalógusban feltüntetett műszaki paraméterek változtatására a termékek és csomagolás technikai fejlesztése és tökéletesítése szerint. Szállító: a szállító fenntartja jogát a nyomtatási és szedési hibákra.

## **IT**

Il fornitore si riserva il diritto di effettuare modifiche e correzioni ai parametri tecnici riportati nel presente catalogo per migliorare e perfezionare dal punto di vista tecnico i prodotti e gli imballaggi. Il fornitore non esclude inoltre l'eventuale presenza di errori di stampa e di impaginazione. Prima dell'installazione, leggere attentamente le istruzioni. Tenere l'istruzione per un uso successivo.

## **PL**

Dostawca zastrzega sobie prawo do zmian oraz dostosowania parametrów technicznych podanych w niniejszym katalogu z uwzględnieniem rozwoju technicznego i udoskonalania produktów oraz opakowań. Dostawca zastrzega sobie prawo do błędów druku oraz typograficznych.

## **PT**

O provedor reserva-se o direito a efectuar alterações e adaptações de parâmetros técnicos mencionados neste catálogo, tendo em consideração o avanço técnico e melhorias de produtos e embalagens. O provedor reserva-se o direito a cometer erros de impressora e de edição.

## **RO**

Furnizorul își rezervă dreptul de a modifica și schimba parametrii tehnici menționați în acest catalog cu privire la evoluția tehnică și perfecționarea produselor și a ambalării. Furnizorul își rezervă dreptul la greșelile de tipar și greșelile privind tarifele.

## **RU**

Поставщик оставляет за собой право на изменение и исправление технических параметров продукции указанной в этом каталоге, с учетом технического развития, а усовершенствования изделий и его упаковки. Поставщик оставляет за собой право на опечатку в тексте и в ценах. Перед установкой и эксплуатацией изделия внимательно ознакомьтесь с настоящим руководством. Сохраните данное руководство для дальнейшего использования.