

KLASIK A CLEAR 2017

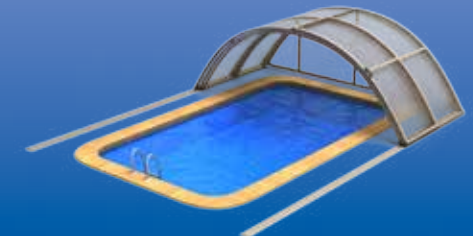

VERZE: 5. 10. 2017 / REVIZE: 5. 10. 2017

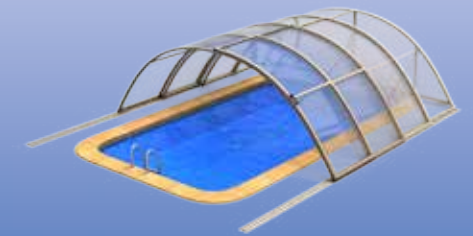
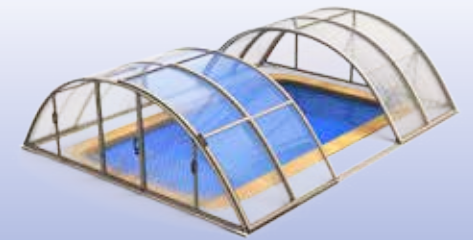
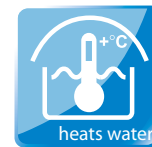

BG
 Тръгва се в България, вие имате право
 да закупите ALBIXON. ИФ P 90-300
 За повече информация относно условията на продажбата
 или за да получите техническите спецификации, моля да се свържете с нашите представители.

DE
 Schwimmbadüberdachung ALBIXON
 Schwimmbecken ALBIXON. ИФ P 90-300
 Die Schwimmbeckenüberdachung ALBIXON
 ist ein Produkt der ALBIXON Group.

ES
 Cubierta de piscinas ALBIXON
 Cubierta de piscinas ALBIXON. ИФ P 90-300
 Este producto está disponible en todos los países
 donde se comercializa el producto.

FR
 Mura de piscine ALBIXON
 Mura de piscine ALBIXON. ИФ P 90-300
 Cette mur de piscine est disponible dans tous
 les pays où le produit est commercialisé.

HU
 Működőanyagok ALBIXON
 Működőanyagok ALBIXON. ИФ P 90-300
 A működésképtelen ALBIXON termékek
 kizárólag a gyártóval vagy az ALBIXON
 képviselővel lehet beszerezni.

CN
 游泳池 遮阳棚
 游泳池遮阳棚 ALBIXON. ИФ P 90-300
 游泳池遮阳棚 ALBIXON. ИФ P 90-300
 游泳池遮阳棚 ALBIXON. ИФ P 90-300

LT
 Šiluminė vonios užtvara ALBIXON
 Šiluminė vonios užtvara ALBIXON. ИФ P 90-300
 Šiluminė vonios užtvara ALBIXON. ИФ P 90-300
 Šiluminė vonios užtvara ALBIXON. ИФ P 90-300

PL
 Zadaszkiwniki ALBIXON
 Zadaszkiwniki ALBIXON. ИФ P 90-300
 Zadaszkiwniki ALBIXON. ИФ P 90-300
 Zadaszkiwniki ALBIXON. ИФ P 90-300

RU
 Крыша для бассейна ALBIXON
 Крыша для бассейна ALBIXON. ИФ P 90-300
 Крыша для бассейна ALBIXON. ИФ P 90-300
 Крыша для бассейна ALBIXON. ИФ P 90-300

SL
 Nadstrešnica ALBIXON
 Nadstrešnica ALBIXON. ИФ P 90-300
 Nadstrešnica ALBIXON. ИФ P 90-300
 Nadstrešnica ALBIXON. ИФ P 90-300

CZ
 Střešní krytka ALBIXON
 Střešní krytka ALBIXON. ИФ P 90-300
 Střešní krytka ALBIXON. ИФ P 90-300
 Střešní krytka ALBIXON. ИФ P 90-300

DK
 Badesvømmehuset ALBIXON
 Badesvømmehuset ALBIXON. ИФ P 90-300
 Badesvømmehuset ALBIXON. ИФ P 90-300
 Badesvømmehuset ALBIXON. ИФ P 90-300

EE
 Ujumisbasseini kaetmine ALBIXON
 Ujumisbasseini kaetmine ALBIXON. ИФ P 90-300
 Ujumisbasseini kaetmine ALBIXON. ИФ P 90-300
 Ujumisbasseini kaetmine ALBIXON. ИФ P 90-300

GB
 Swimming pool enclosure ALBIXON
 Swimming pool enclosure ALBIXON. ИФ P 90-300
 Swimming pool enclosure ALBIXON. ИФ P 90-300
 Swimming pool enclosure ALBIXON. ИФ P 90-300

HR
 Nadstrešnica ALBIXON
 Nadstrešnica ALBIXON. ИФ P 90-300
 Nadstrešnica ALBIXON. ИФ P 90-300
 Nadstrešnica ALBIXON. ИФ P 90-300



IT
 Copertura per piscine ALBIXON
 Copertura per piscine ALBIXON. ИФ P 90-300
 Copertura per piscine ALBIXON. ИФ P 90-300
 Copertura per piscine ALBIXON. ИФ P 90-300

LV
 Bādiņas jumts ALBIXON
 Bādiņas jumts ALBIXON. ИФ P 90-300
 Bādiņas jumts ALBIXON. ИФ P 90-300
 Bādiņas jumts ALBIXON. ИФ P 90-300

RO
 Acoperiș pentru piscină ALBIXON
 Acoperiș pentru piscină ALBIXON. ИФ P 90-300
 Acoperiș pentru piscină ALBIXON. ИФ P 90-300
 Acoperiș pentru piscină ALBIXON. ИФ P 90-300

SE
 Poolöverdning ALBIXON
 Poolöverdning ALBIXON. ИФ P 90-300
 Poolöverdning ALBIXON. ИФ P 90-300
 Poolöverdning ALBIXON. ИФ P 90-300

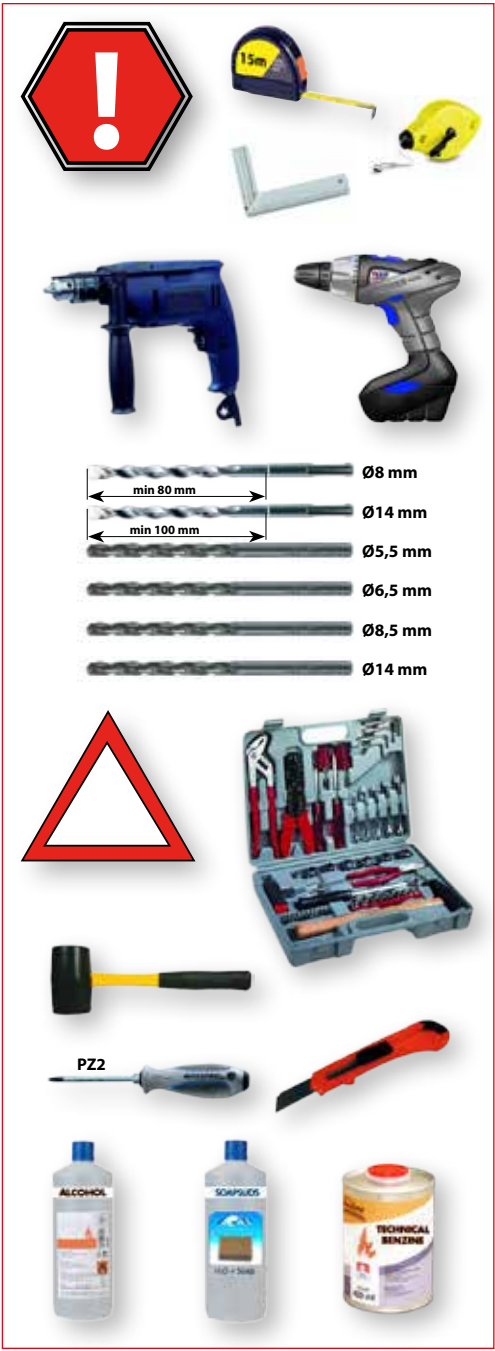
SK
 Střešní krytka ALBIXON
 Střešní krytka ALBIXON. ИФ P 90-300
 Střešní krytka ALBIXON. ИФ P 90-300
 Střešní krytka ALBIXON. ИФ P 90-300





DIN 7982
4,8 x 13
16x
1

650.01.8811.2

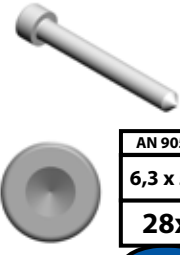

12x
2



AN 9051
6,3 x 50
28x
3

007.20.1501.2



4x
4



DIN 7976
6,3 x 38
4x
5

650.01.0021.2



4x
6

007.02.0030.2



Ø4 x 10
36x
7

007.20.1605.2



1x
8

007.10.7012.2



Ø8 x 80
48x
9

007.90.7022.2



1x
10

007.02.0092.2



Ø4 x 14
4x
11

007.90.4505.2



4x
12

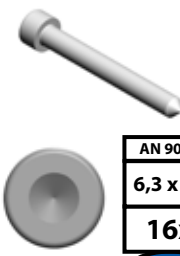

AN 9051
6,3 x 38
16x
13



Ø4,2
1x
14



1x
17



1x
18

097.02.0040.2



2x
19

097.02.0041.2



2x
20

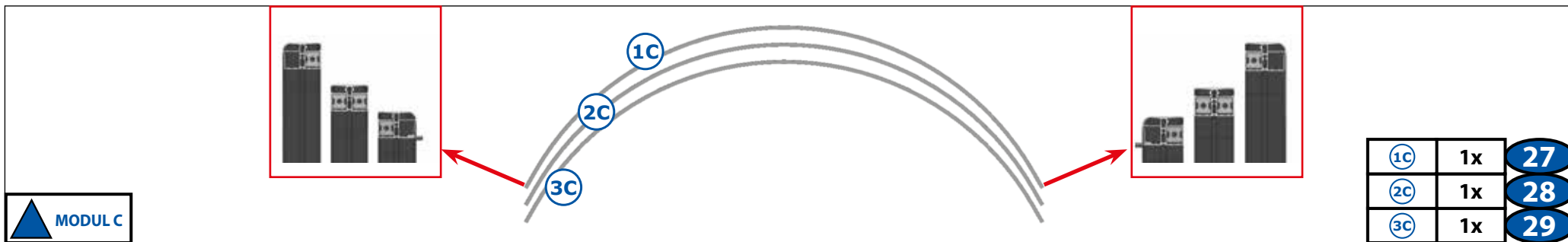
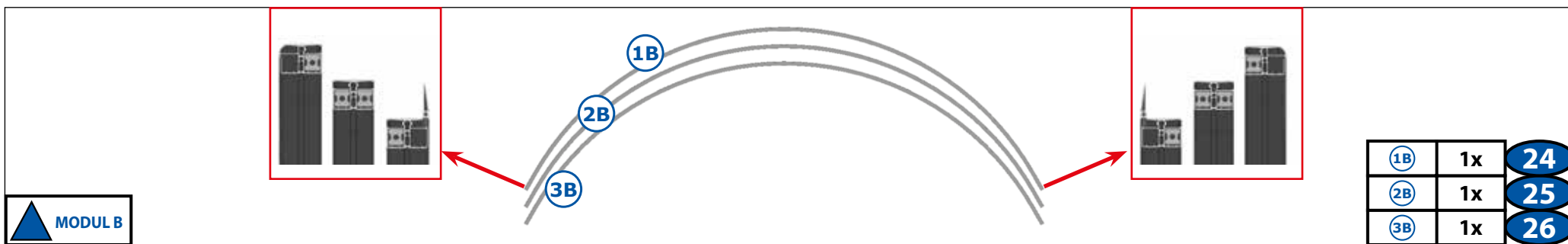
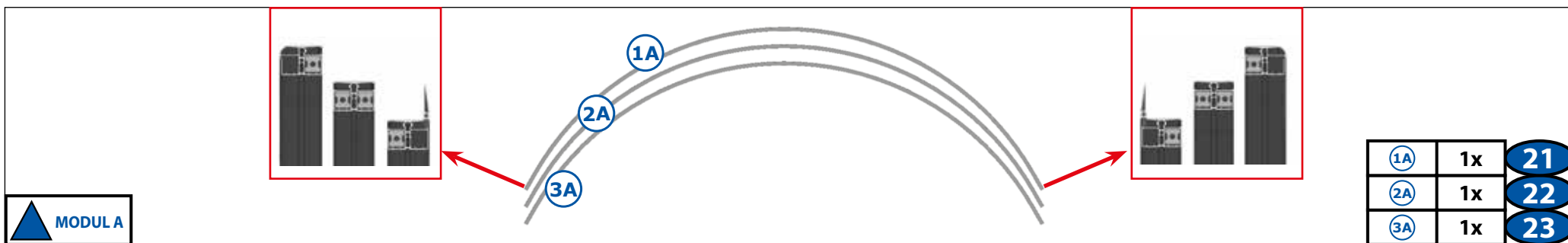
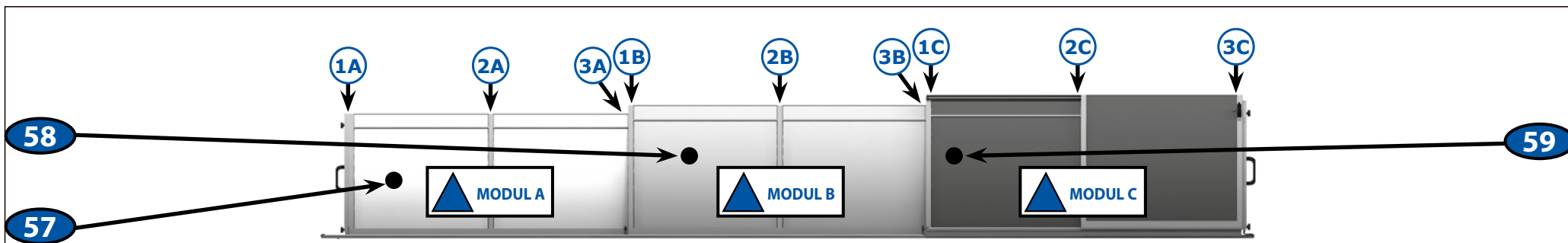



1041 mm
16x
36

A
3230 mm
2x
40

D
3230 mm
2x
46

3230 mm
12x
48

MODUL C

1x
50

MODUL C

1x
51

MODUL B

1x
52

MODUL B

1x
53

MODUL A

1x
54

MODUL A

1x
55

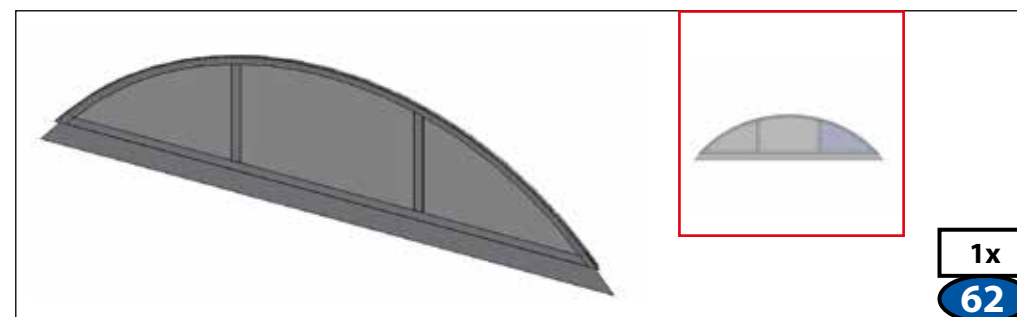
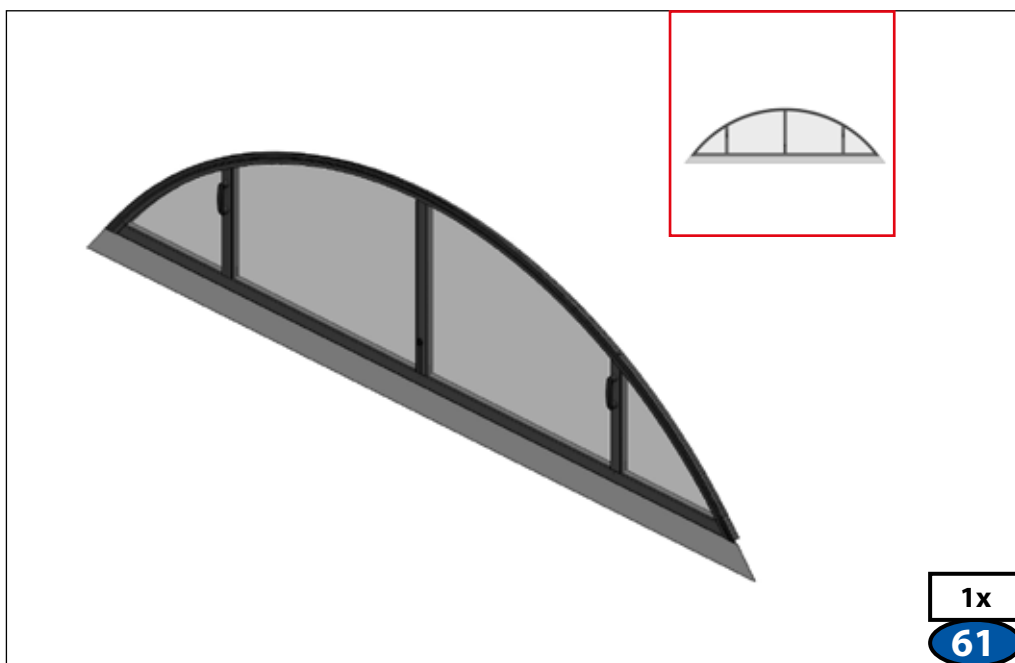
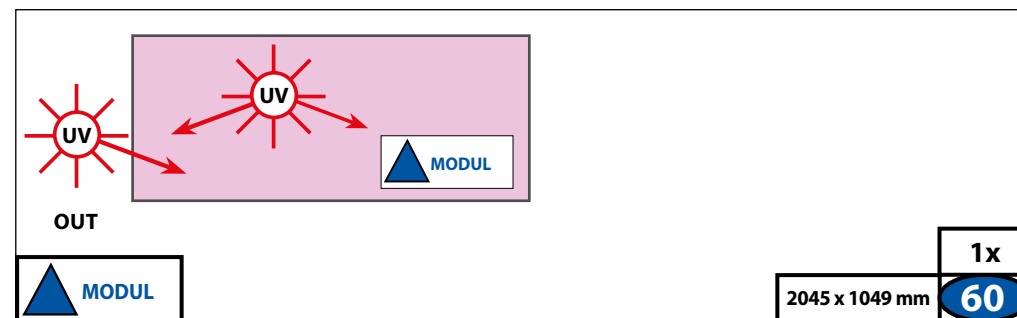
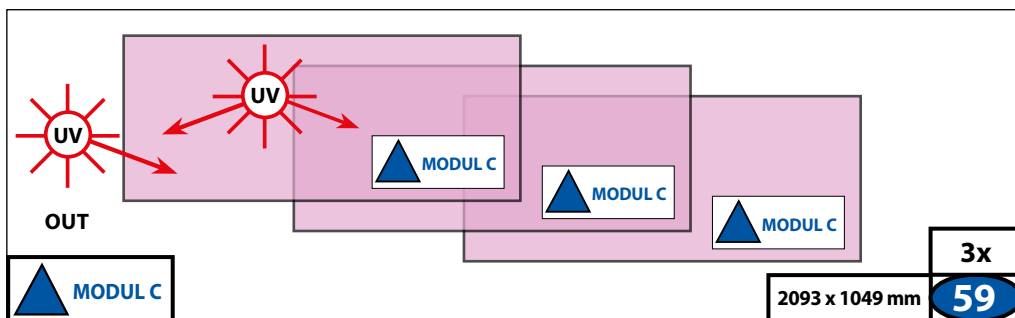
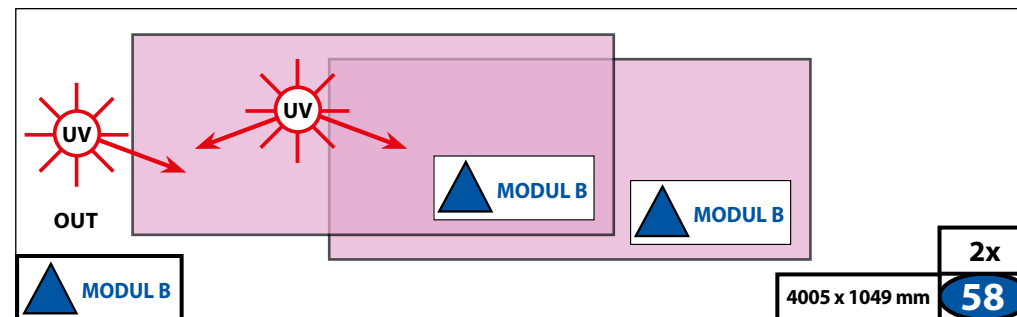
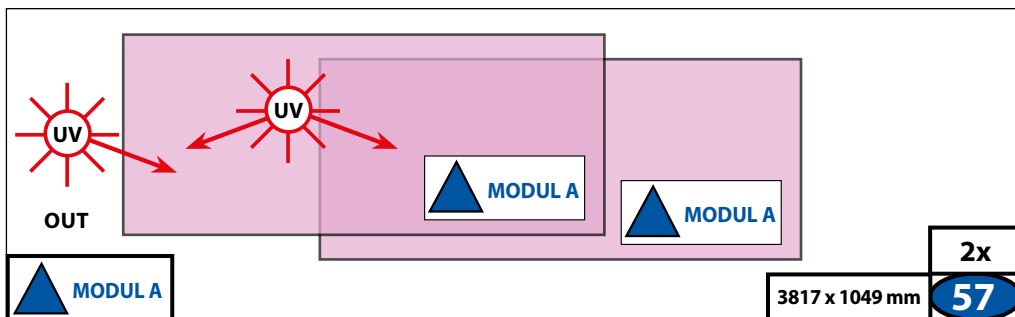



1x
69

1x
70

1x
2150 mm **71**

1x
2150 mm **72**

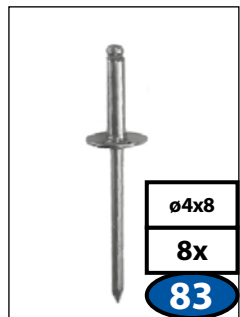
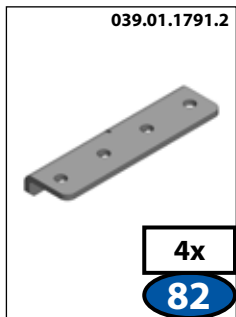
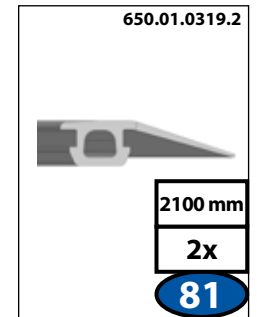
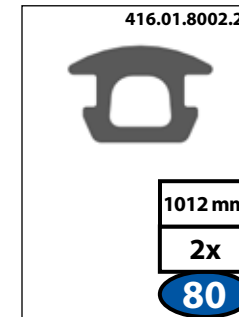
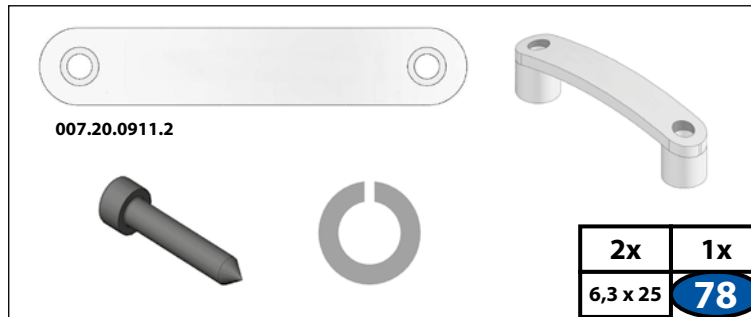
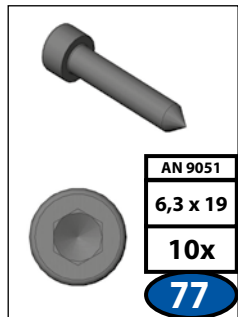
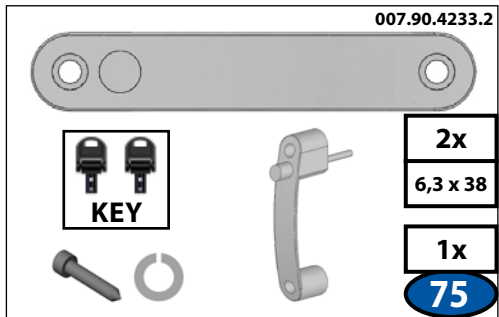
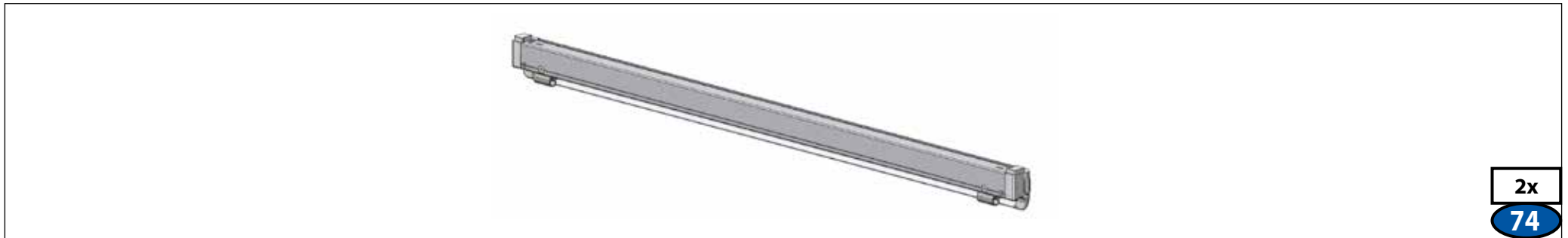
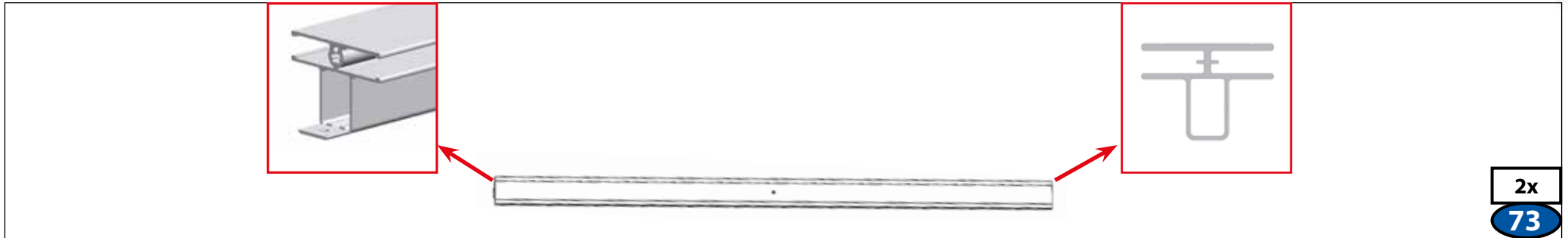



Diagram of a window frame section labeled **MODUL A**. It shows a cross-section with a red box highlighting a specific component. A table to the right lists dimensions and quantities:

3 817 mm	4x
1 030 mm	4x

The number **92** is displayed in a blue box at the bottom right.

Diagram of a window frame section labeled **MODUL B**. It shows a cross-section with a red box highlighting a specific component. A table to the right lists dimensions and quantities:

4 005 mm	4x
1 030 mm	4x

The number **93** is displayed in a blue box at the bottom right.

Diagram of a window frame section labeled **MODUL C**. It shows a cross-section with a red box highlighting a specific component. A table to the right lists dimensions and quantities:

2 093 mm	6x
1 030 mm	6x

The number **94** is displayed in a blue box at the bottom right.

Diagram of a window frame section labeled **MODUL**. It shows a cross-section with a red box highlighting a specific component. A table to the right lists dimensions and quantities:

2 045 mm	2x
1 030 mm	2x

The number **95** is displayed in a blue box at the bottom right.

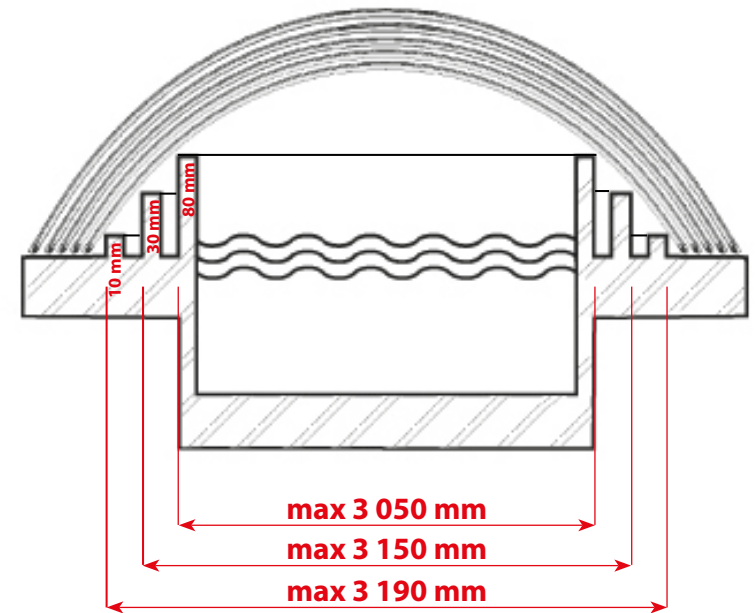
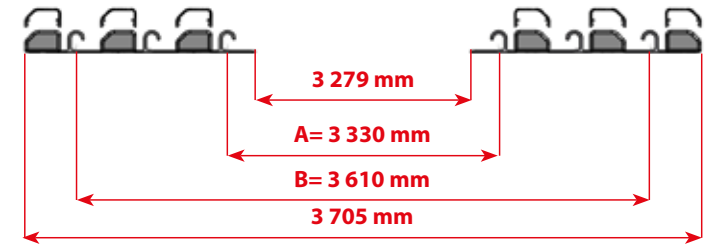
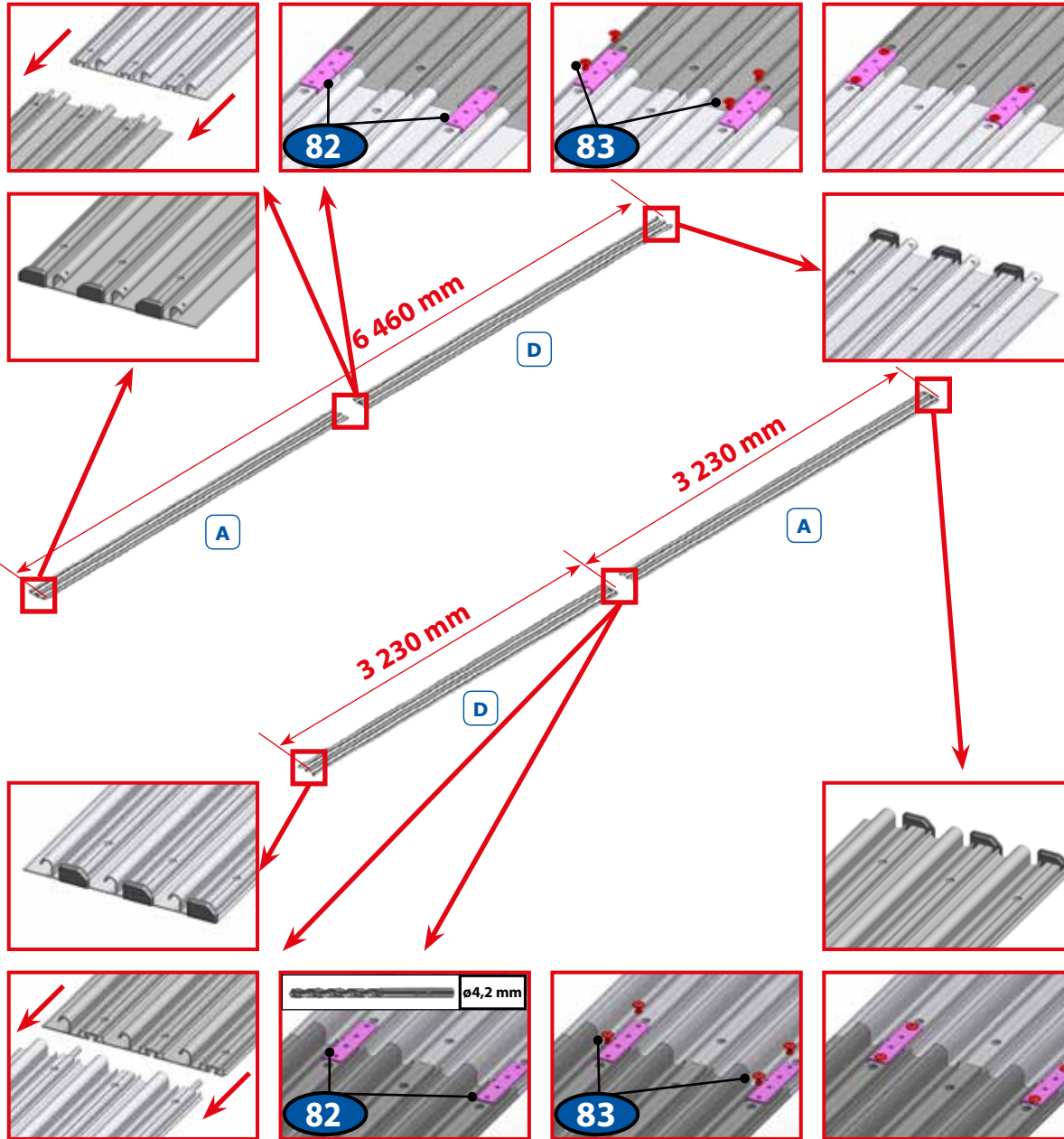

2x	41
2x	47

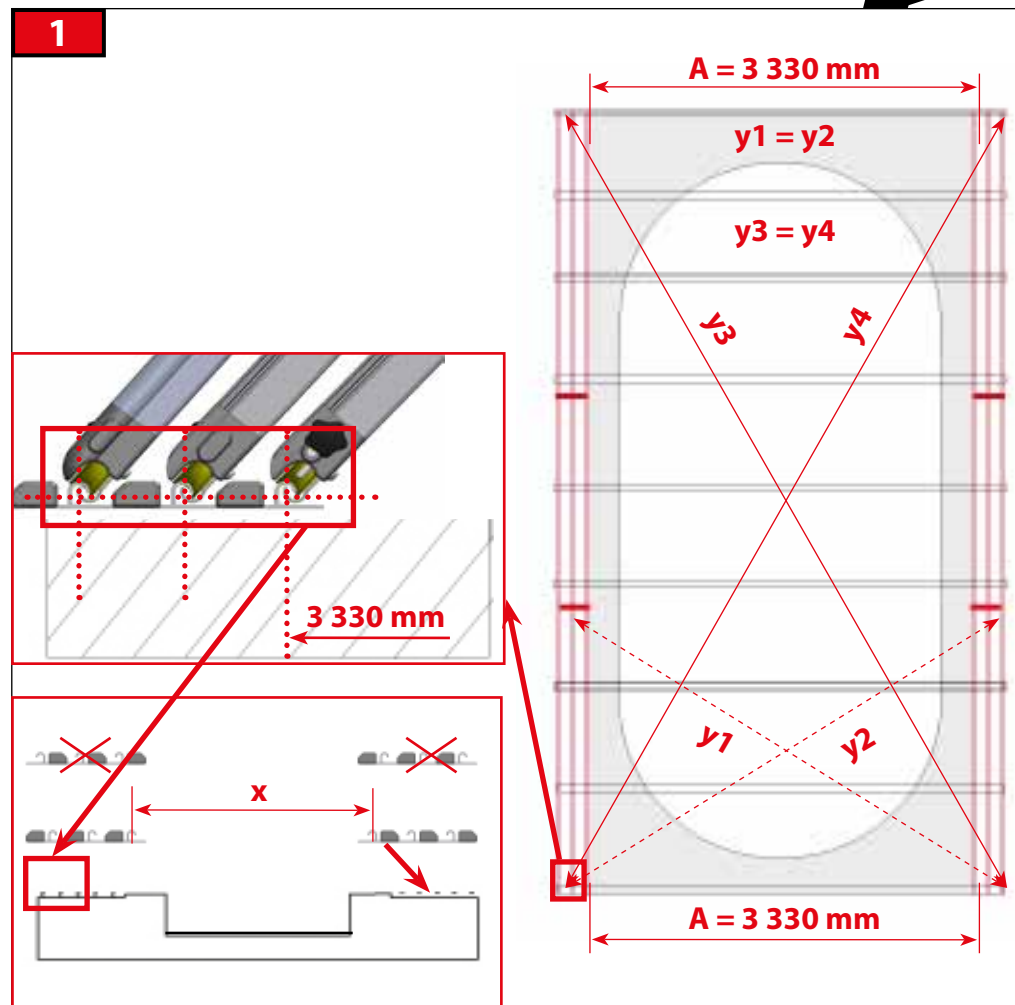
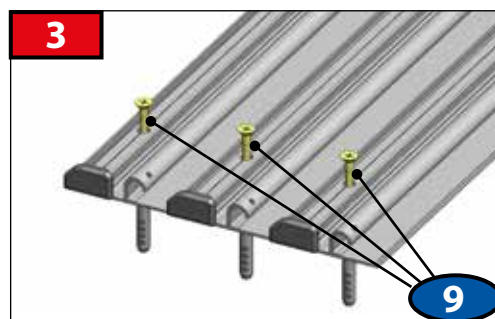
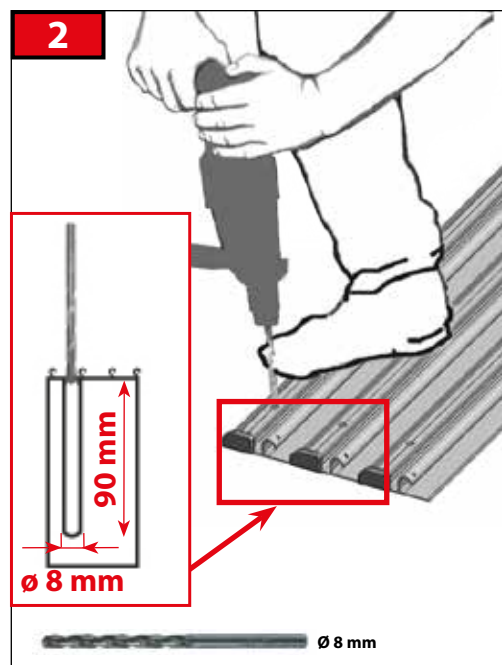
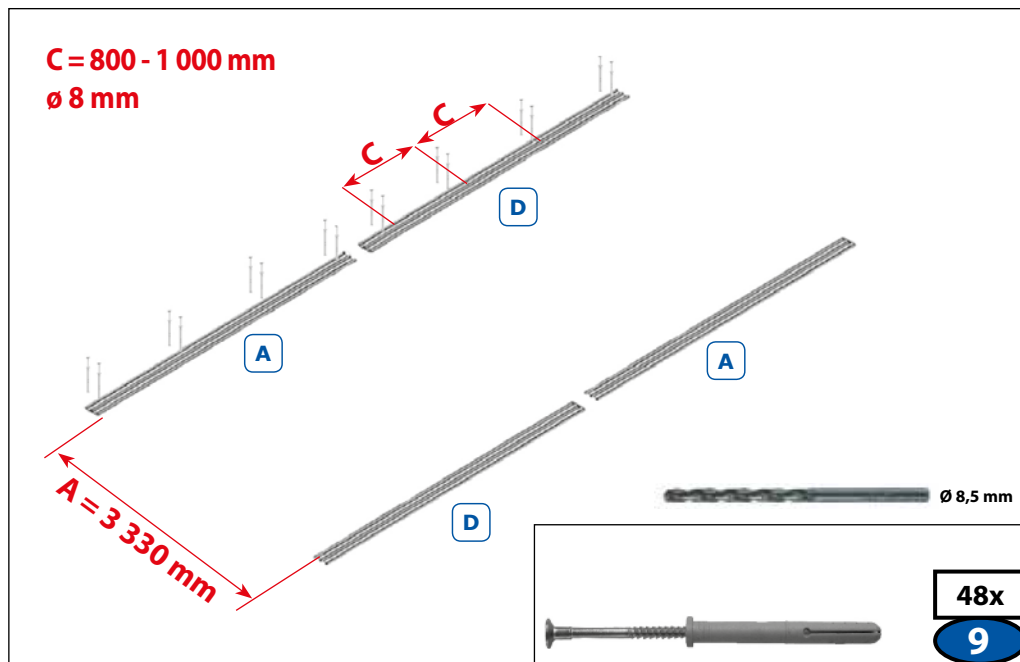



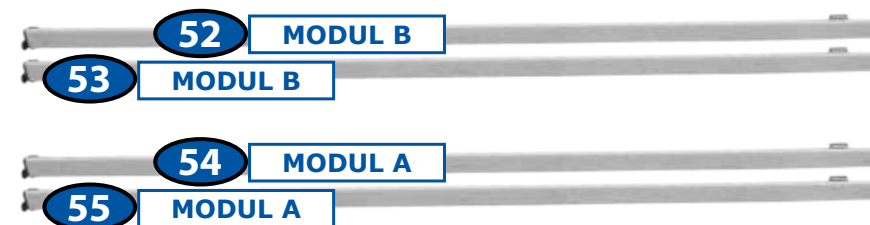
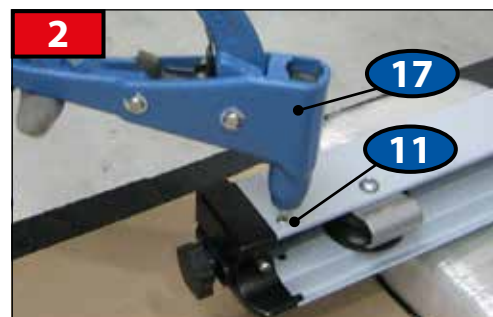
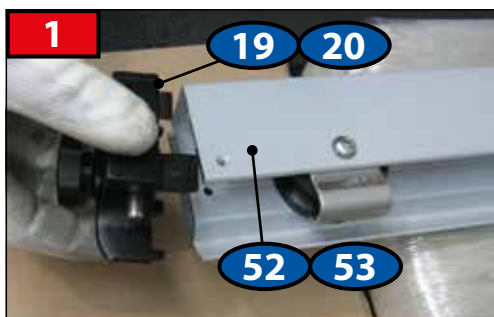
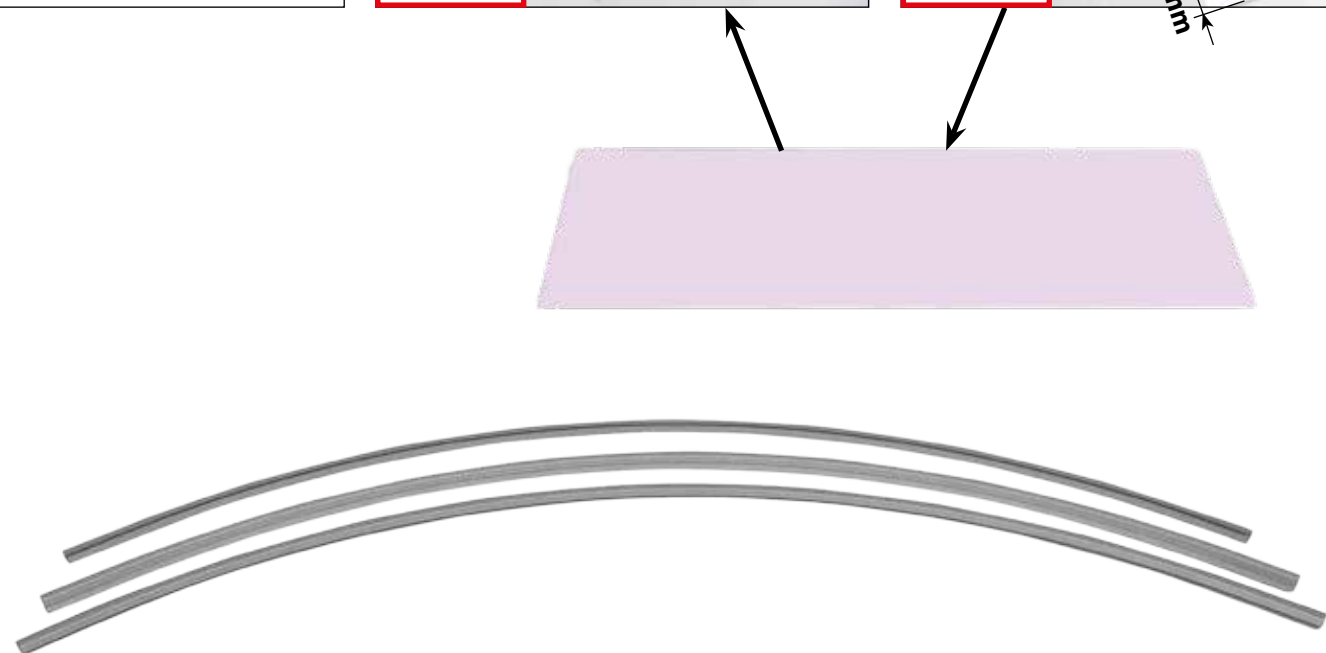
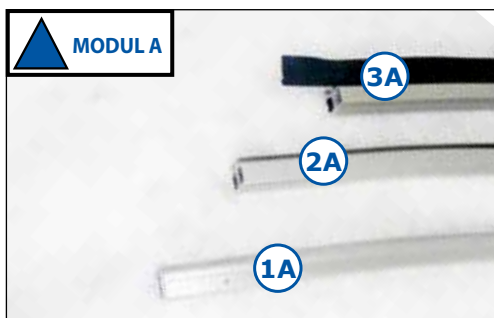
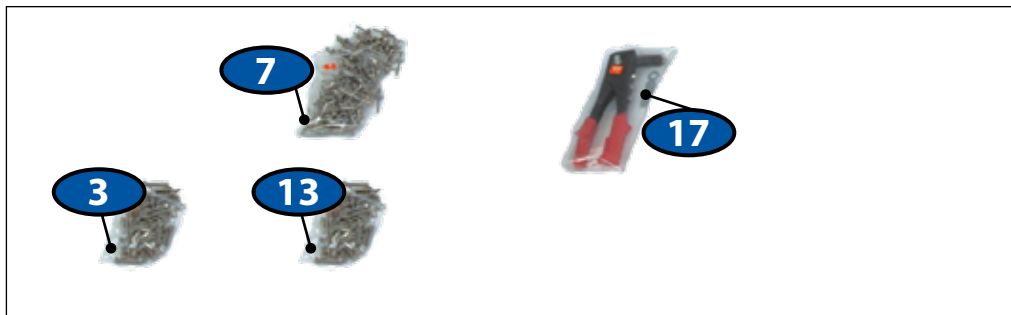

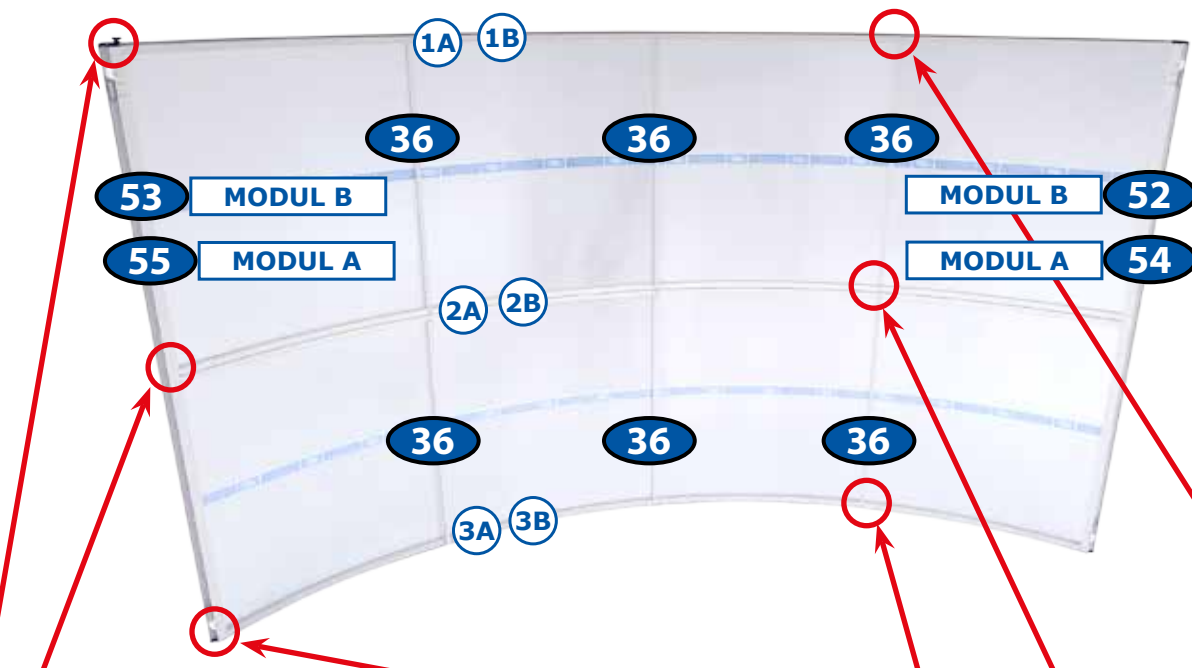
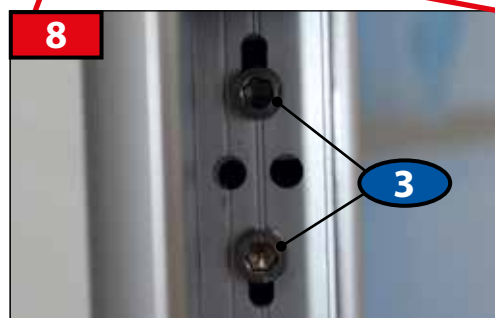
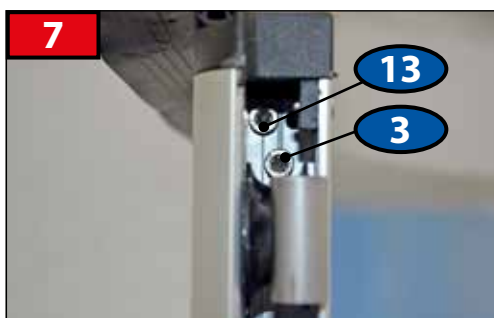
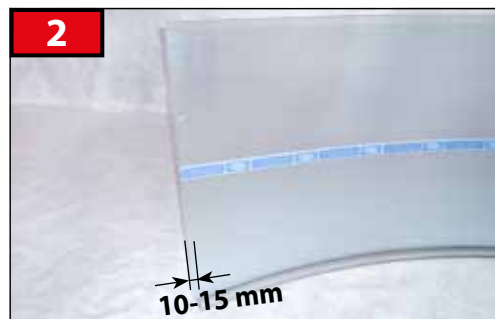

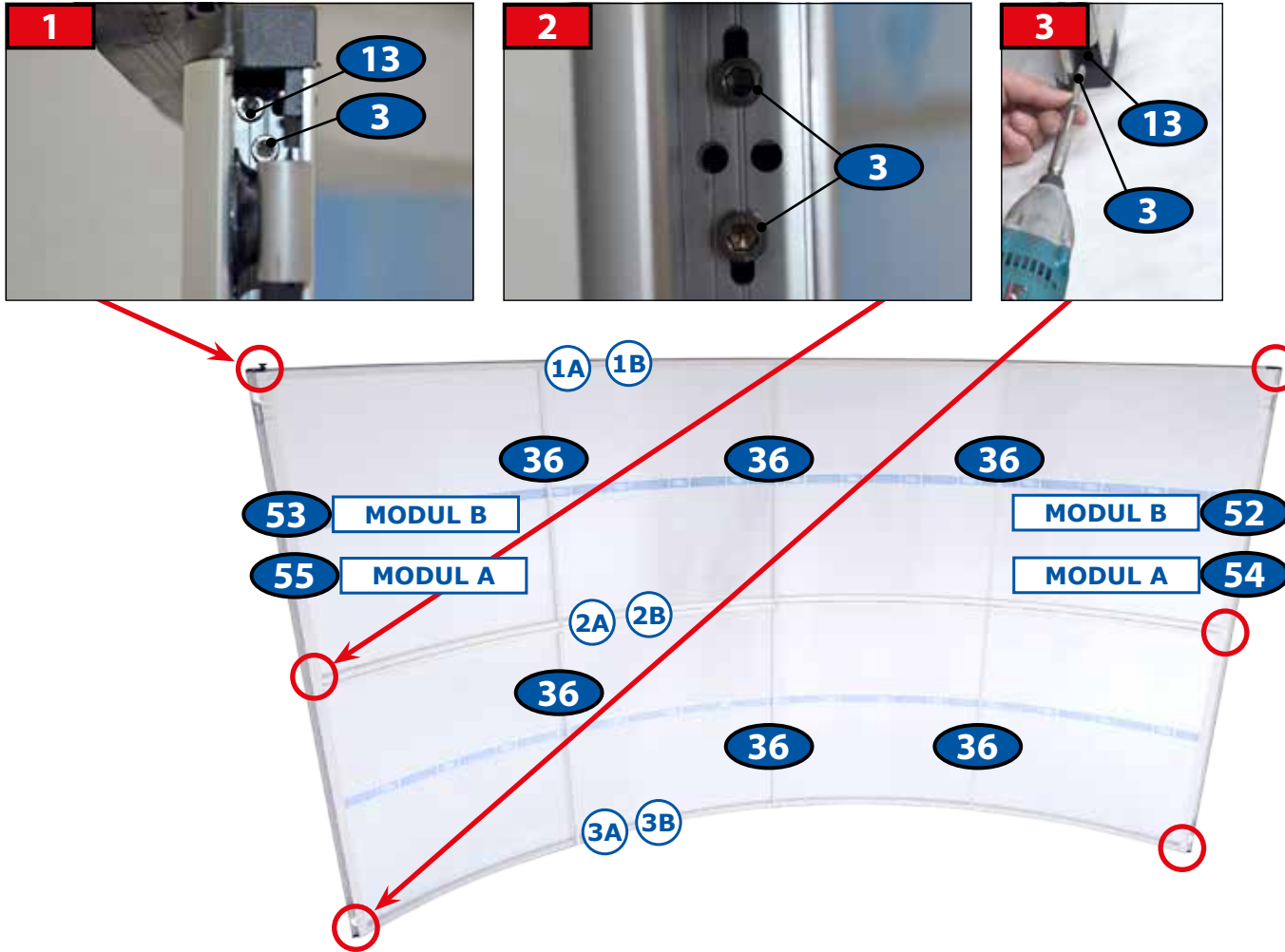

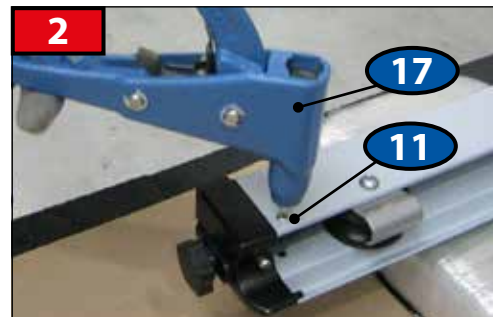
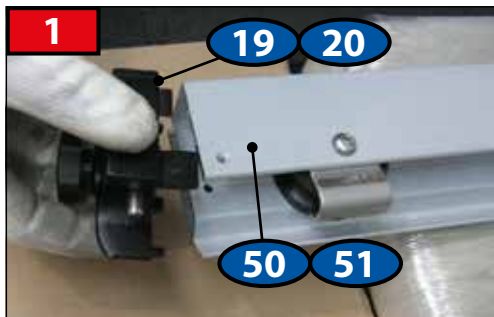
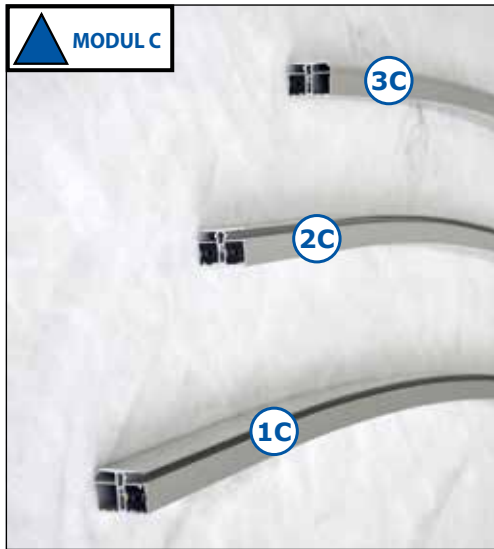
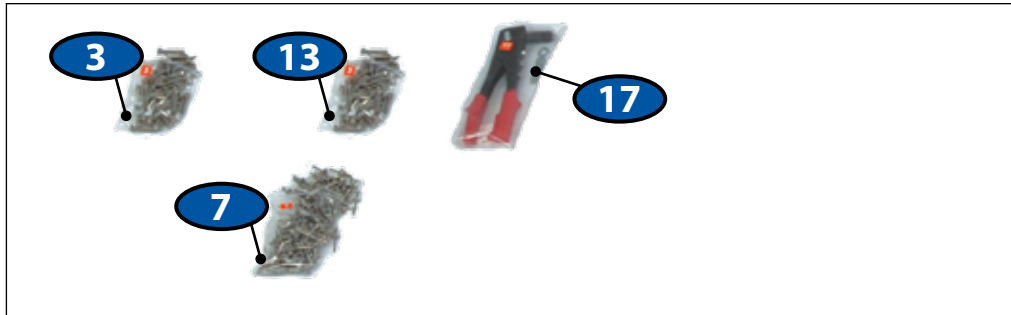



DOOR LEFT

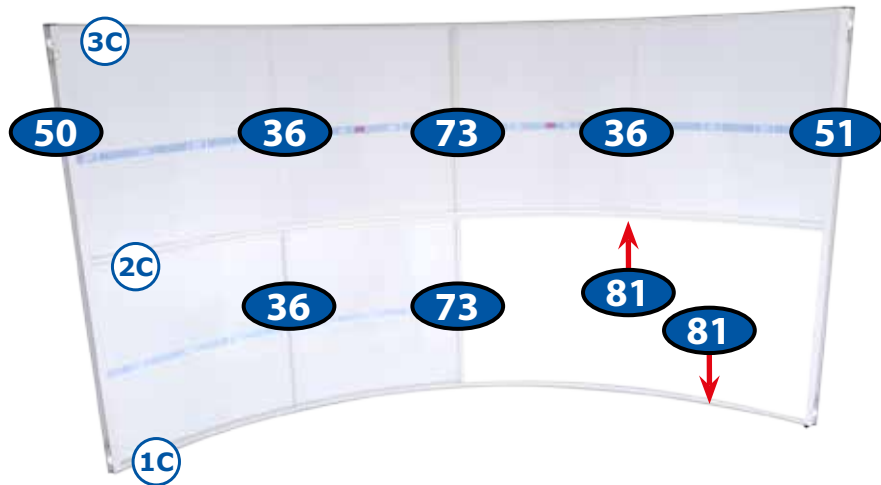
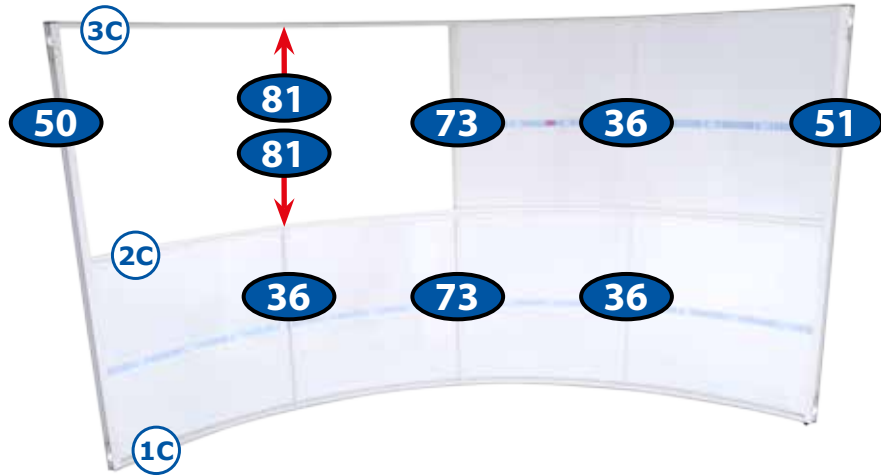

DOOR RIGHT

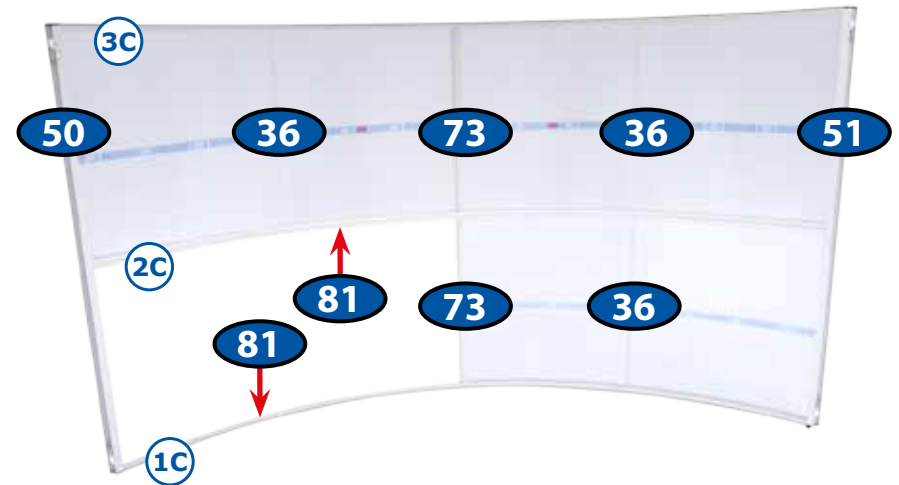
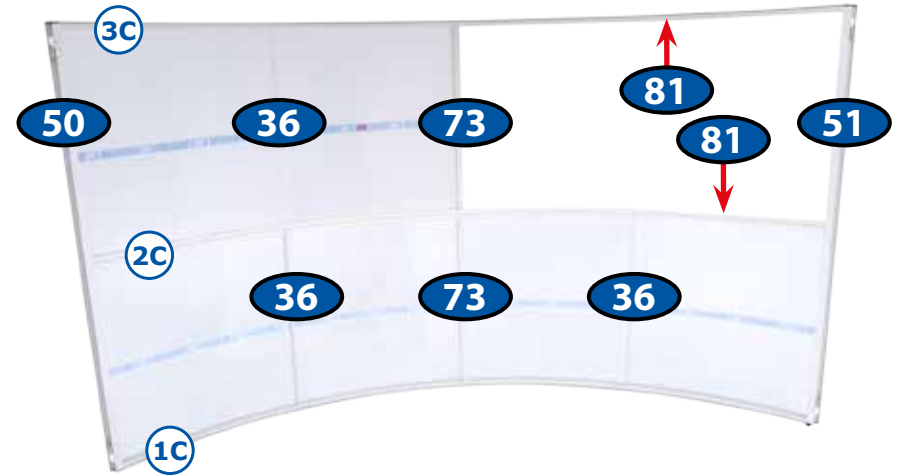

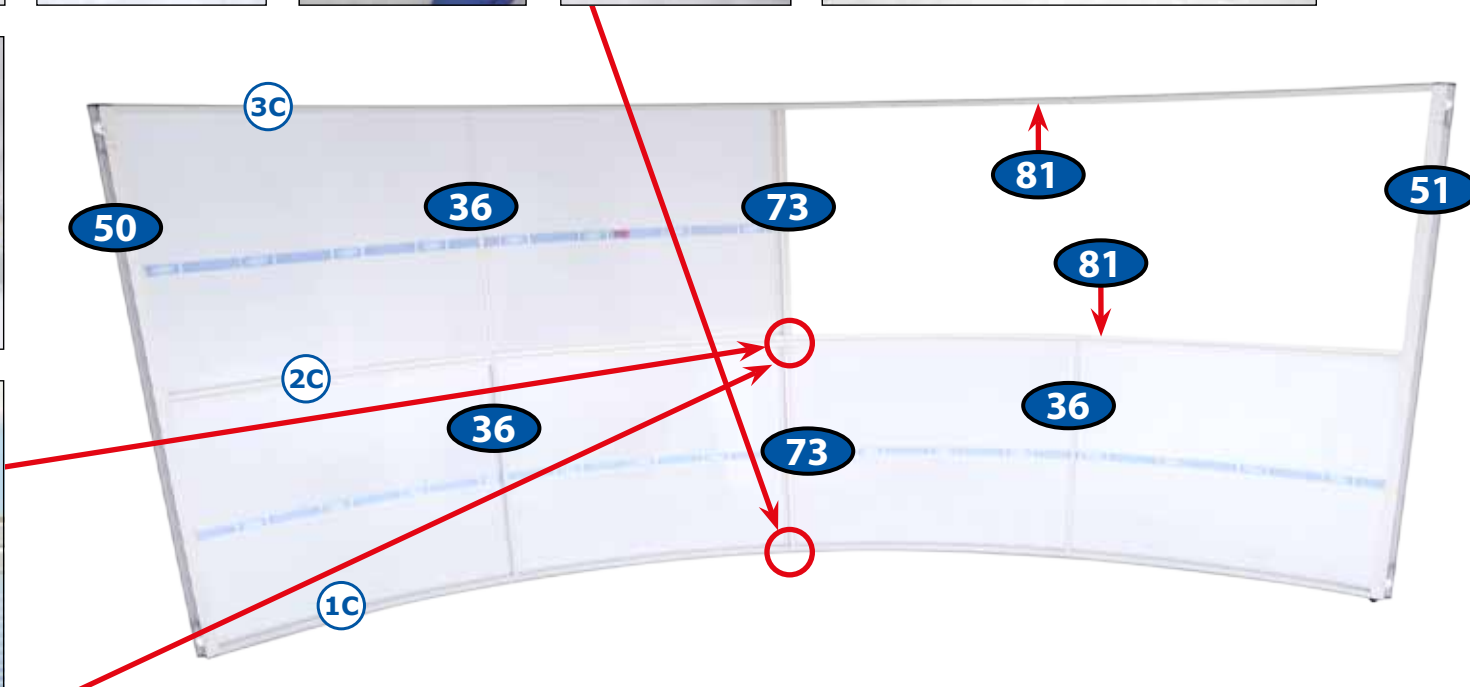
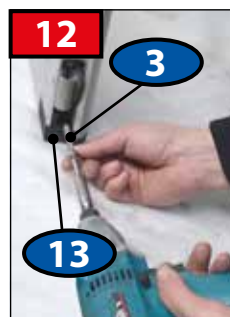
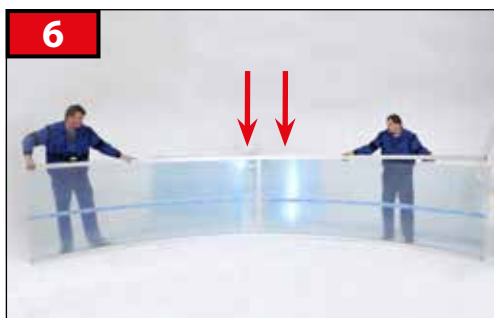

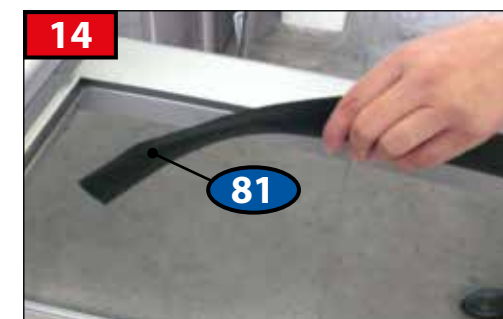
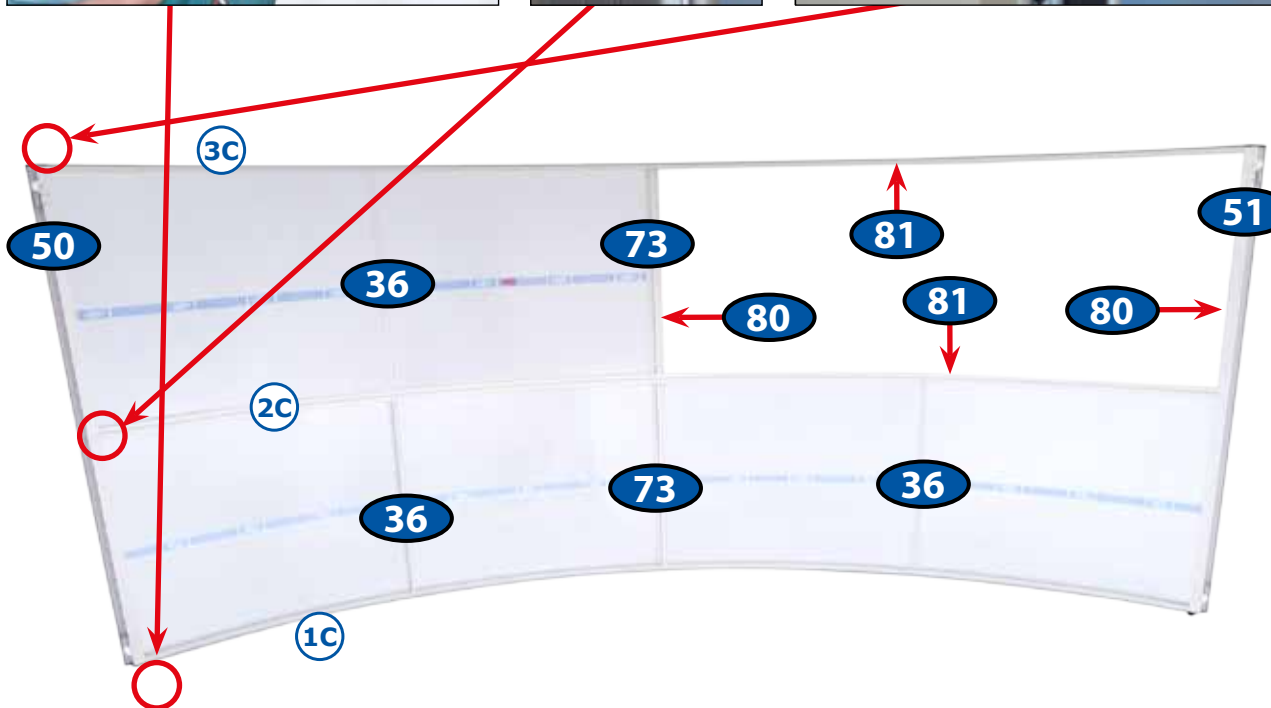
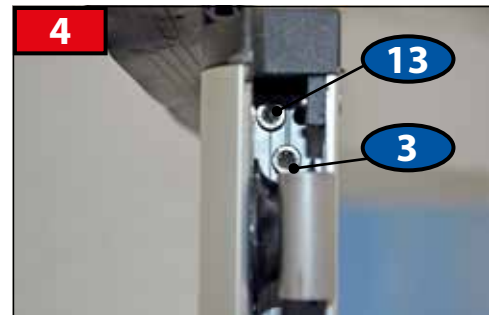

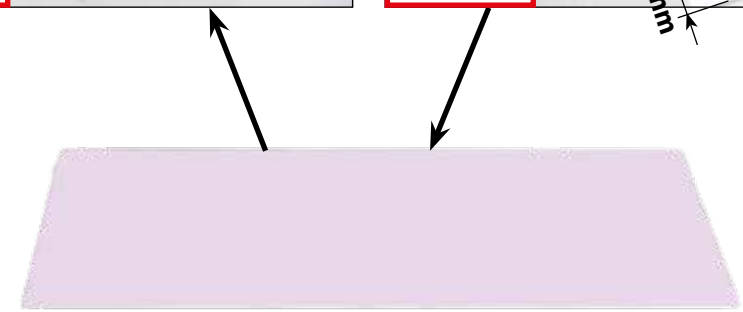
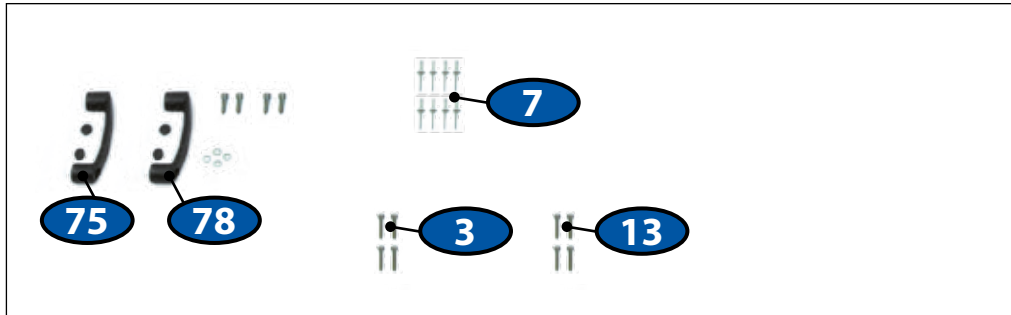

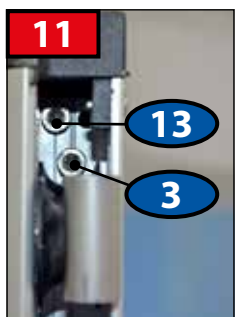
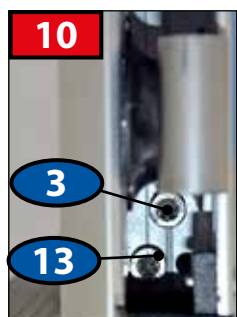
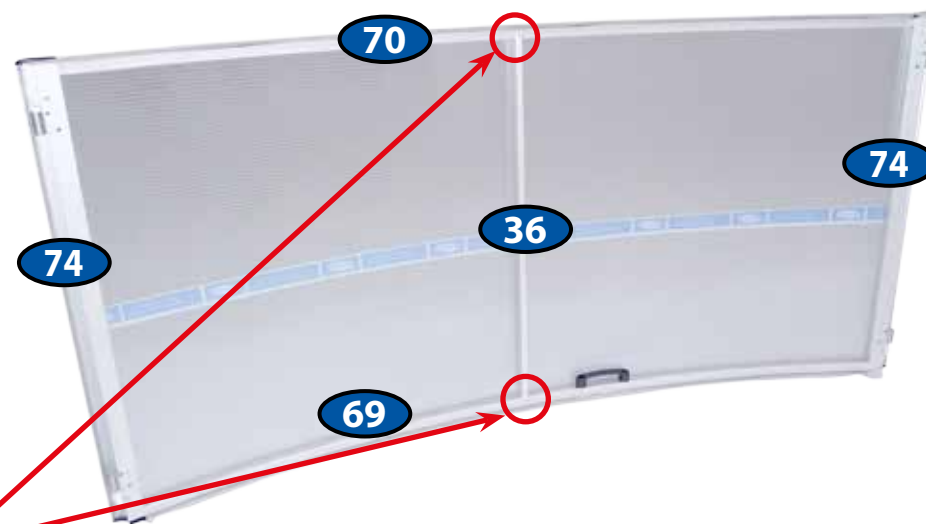

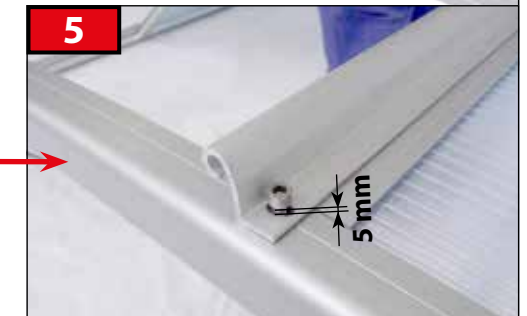
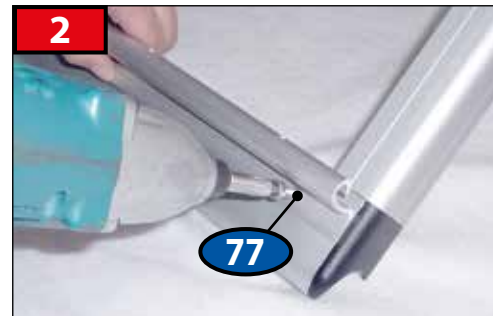
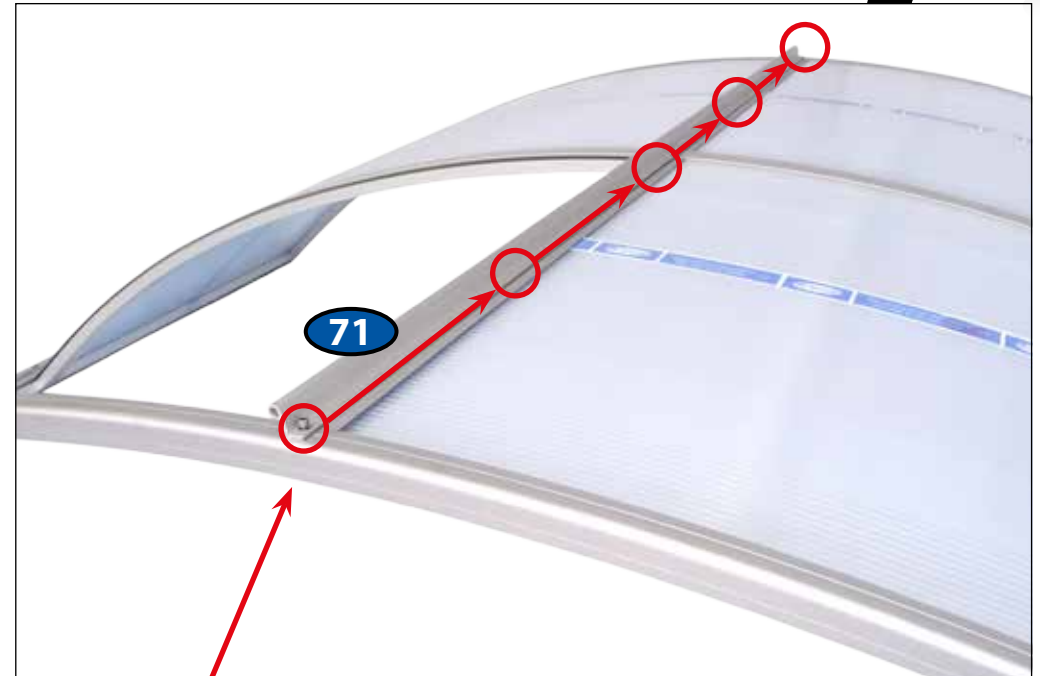

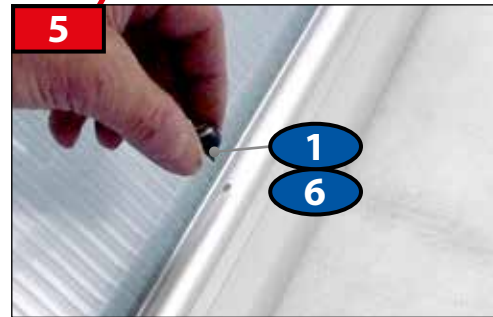
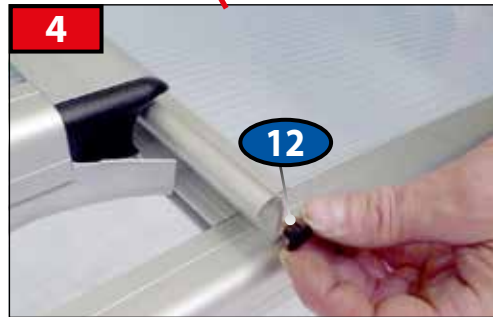
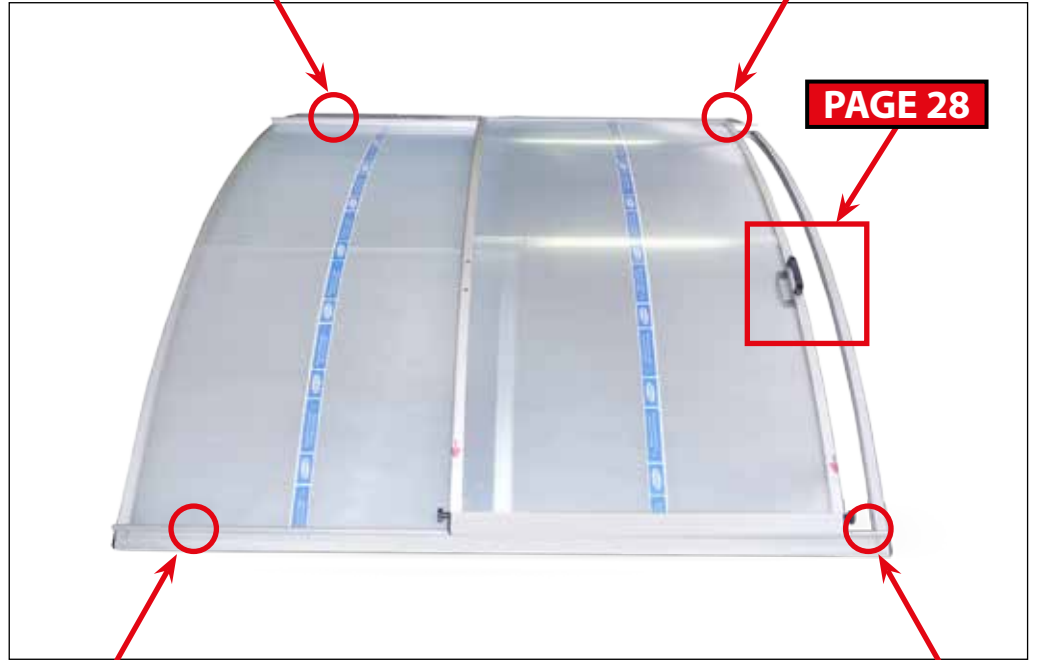
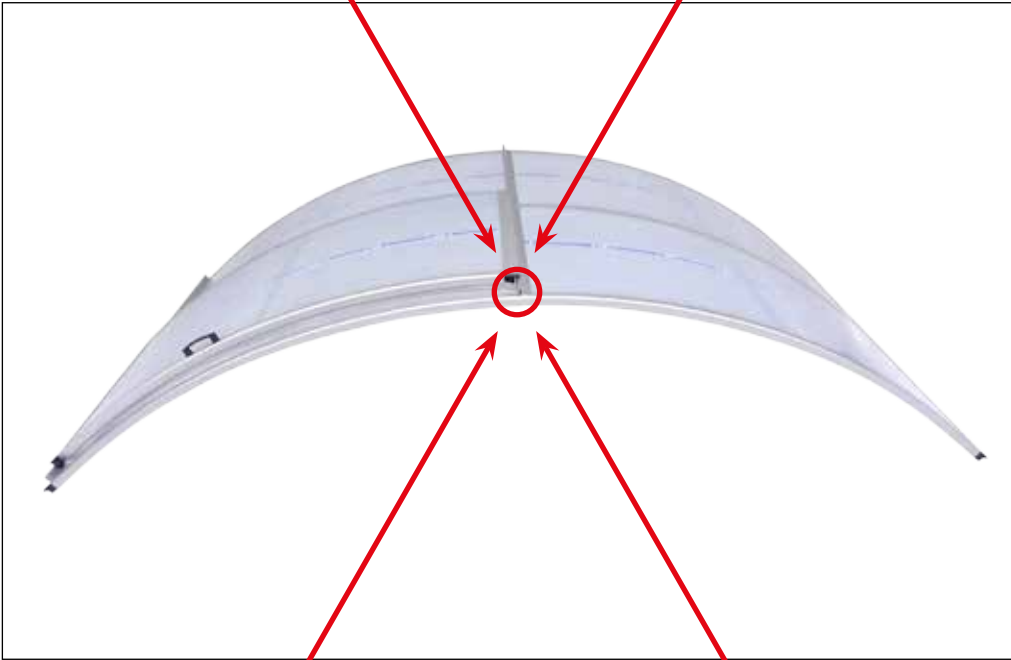
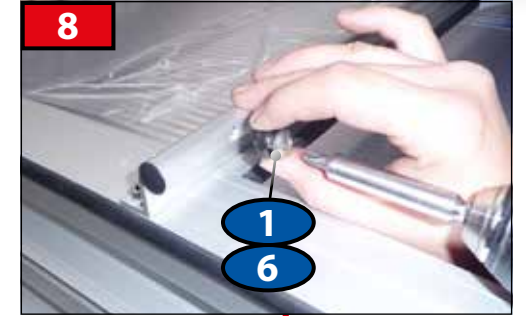

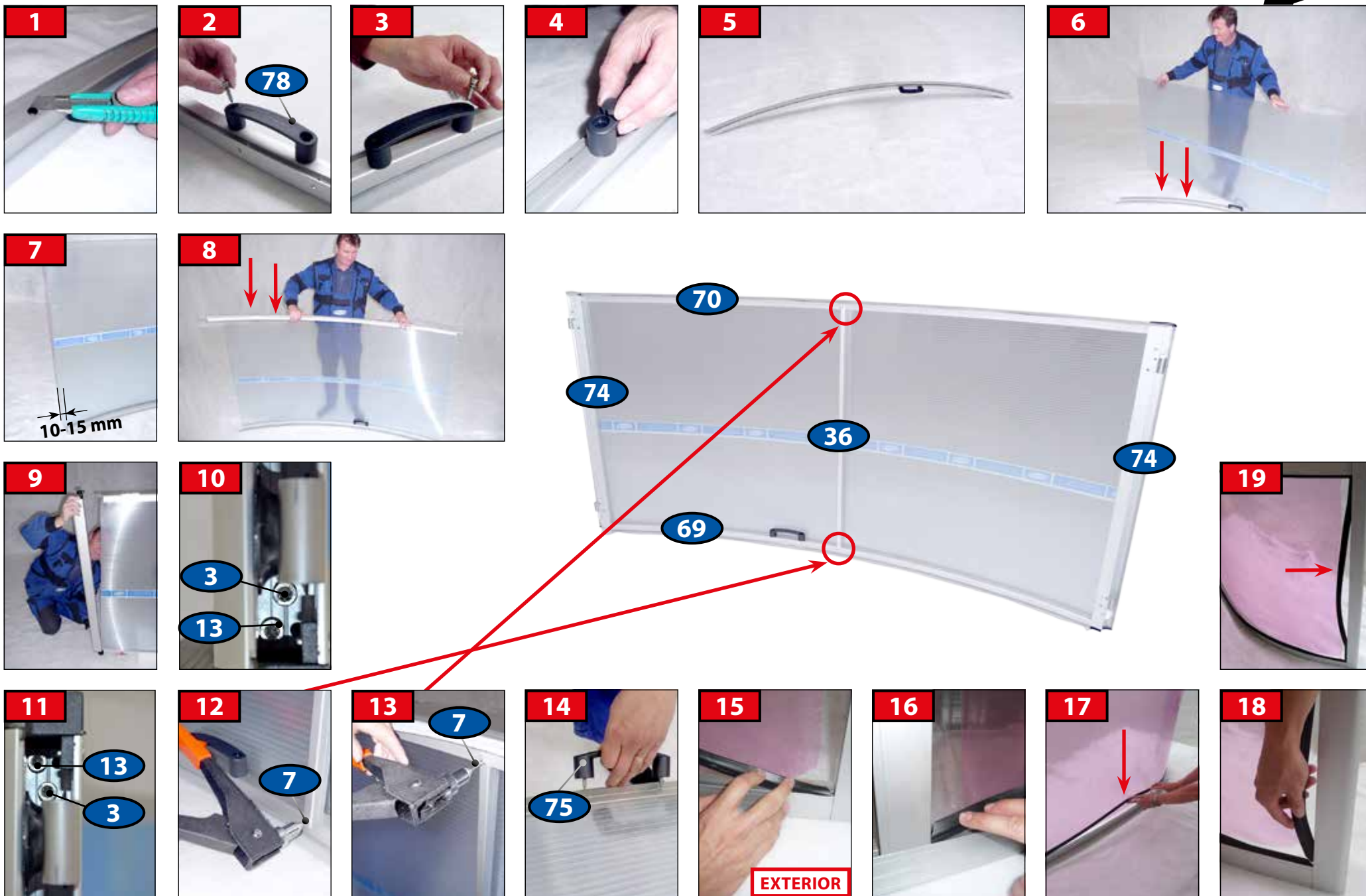

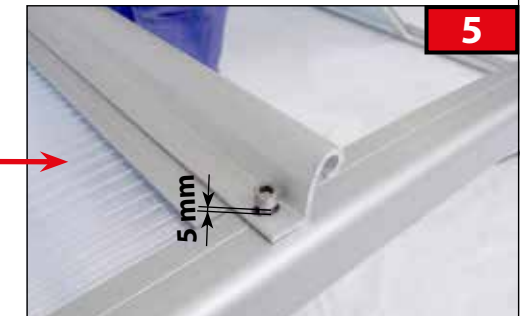
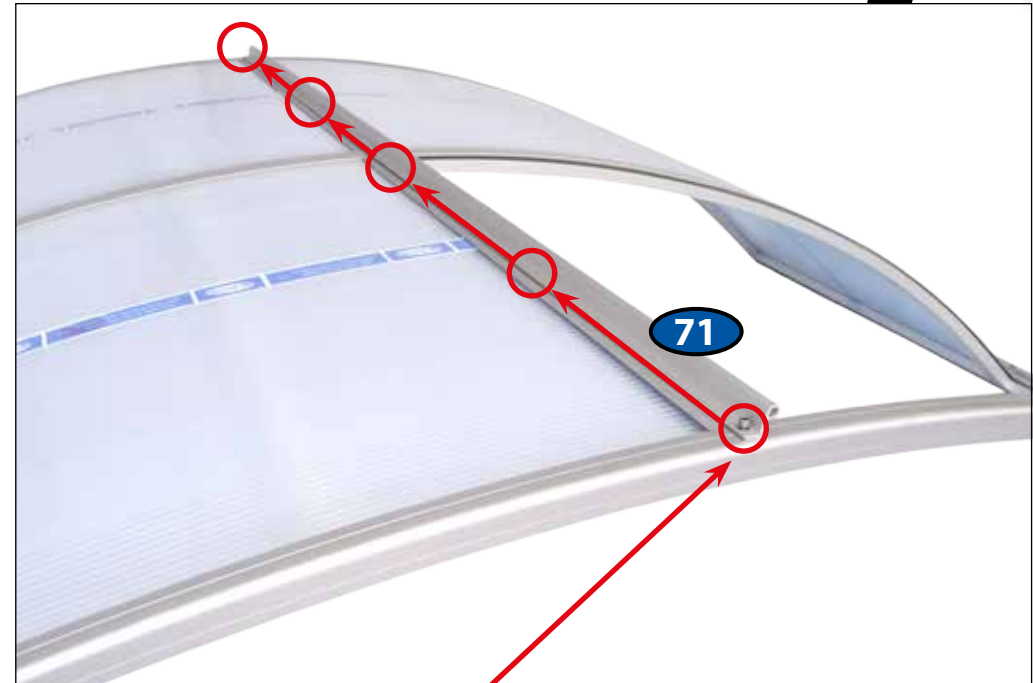

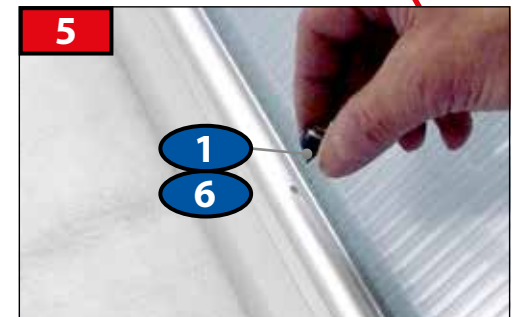
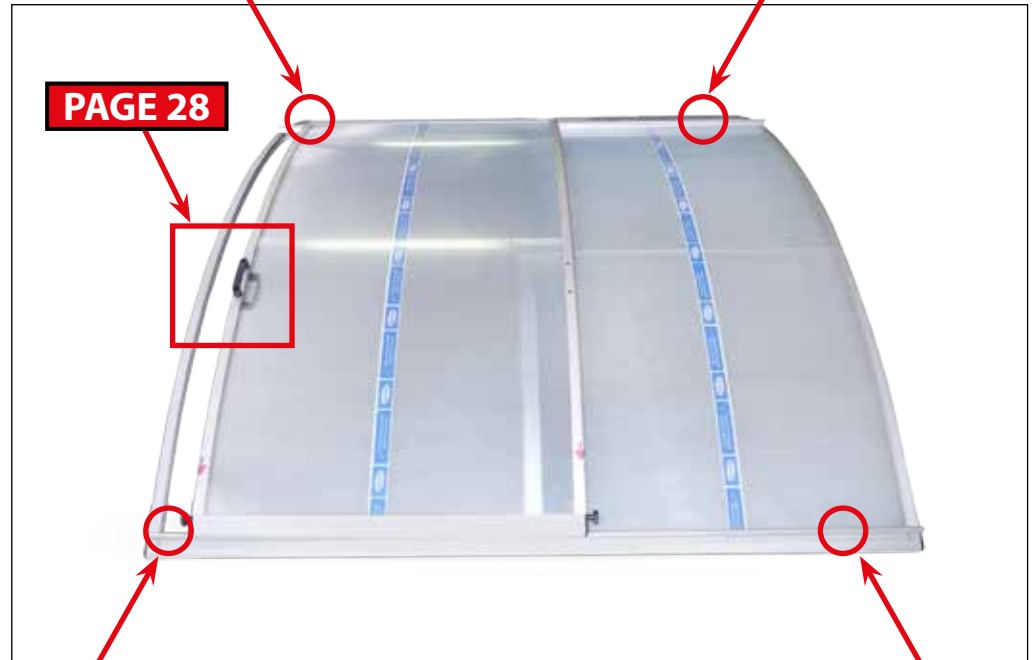
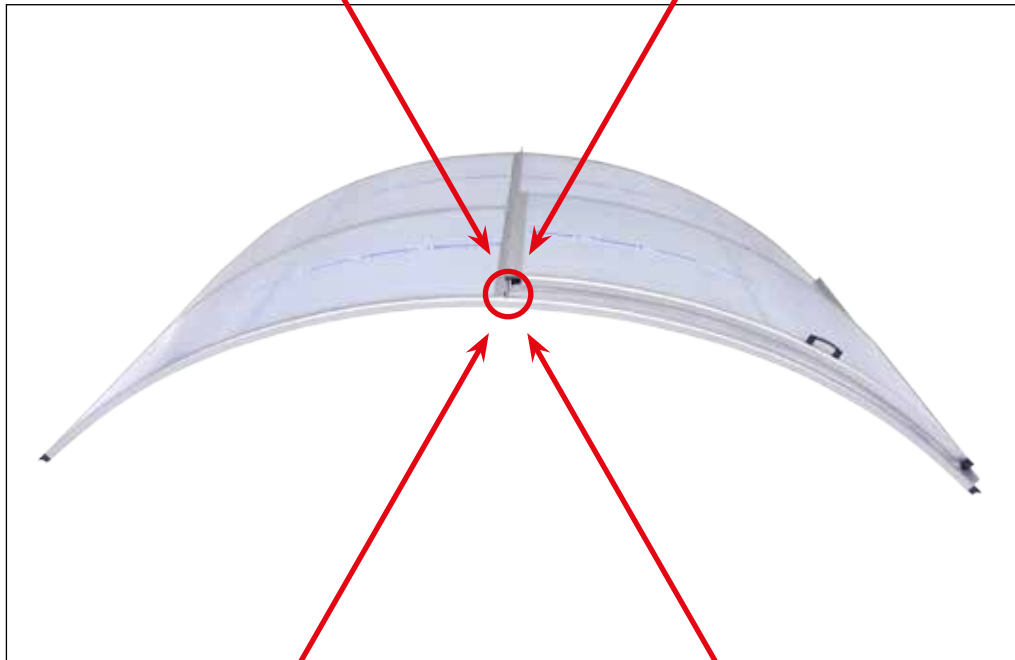
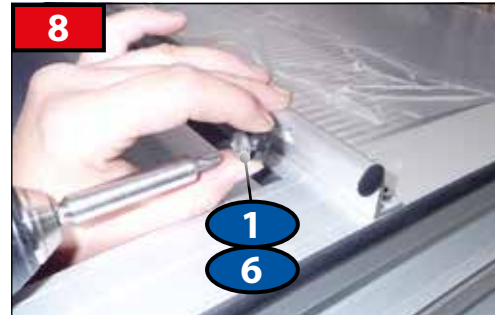

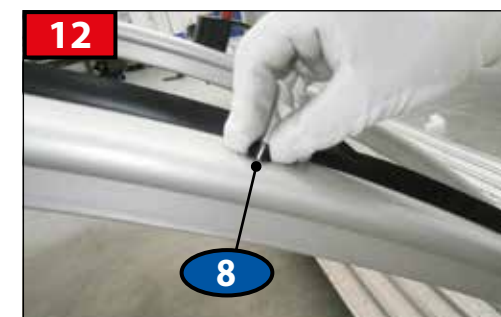
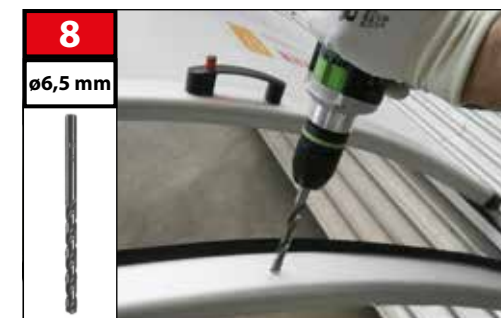
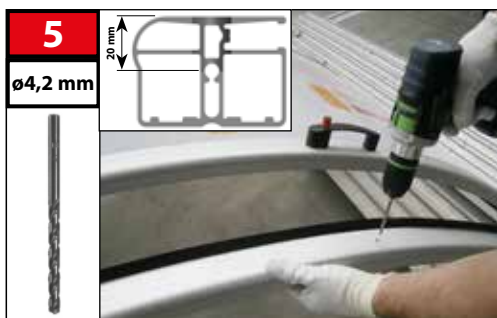
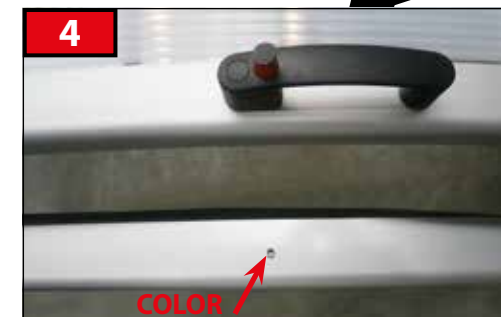

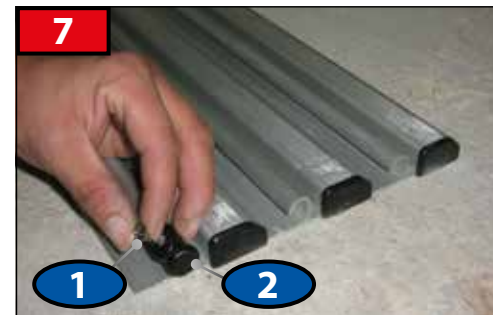
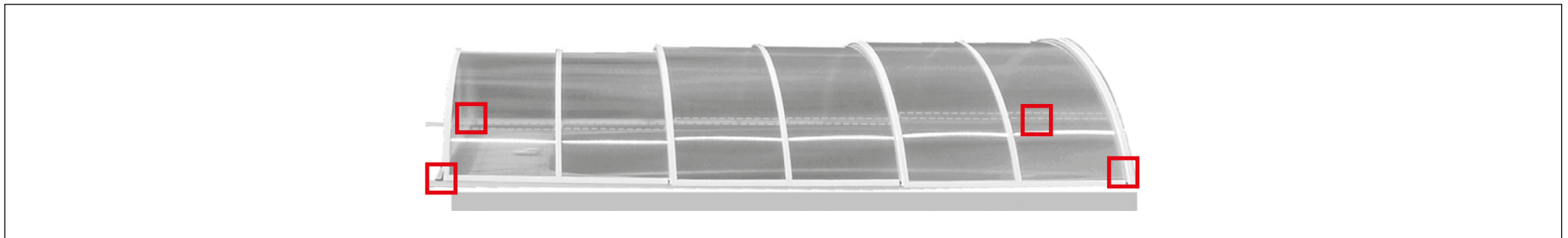
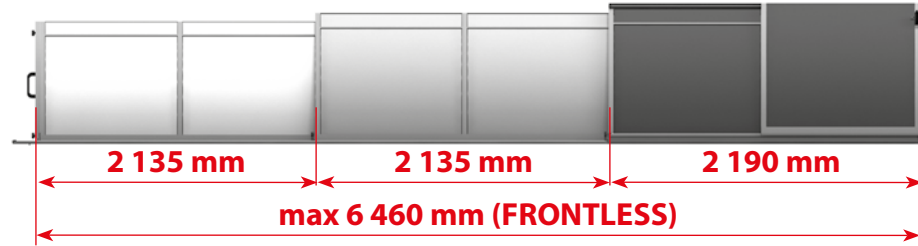

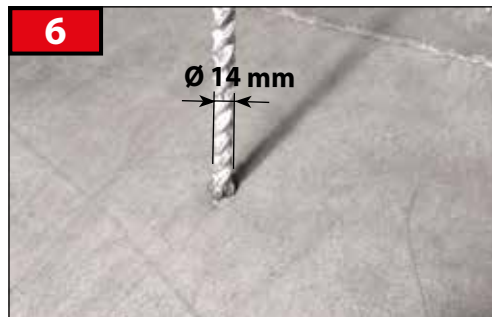
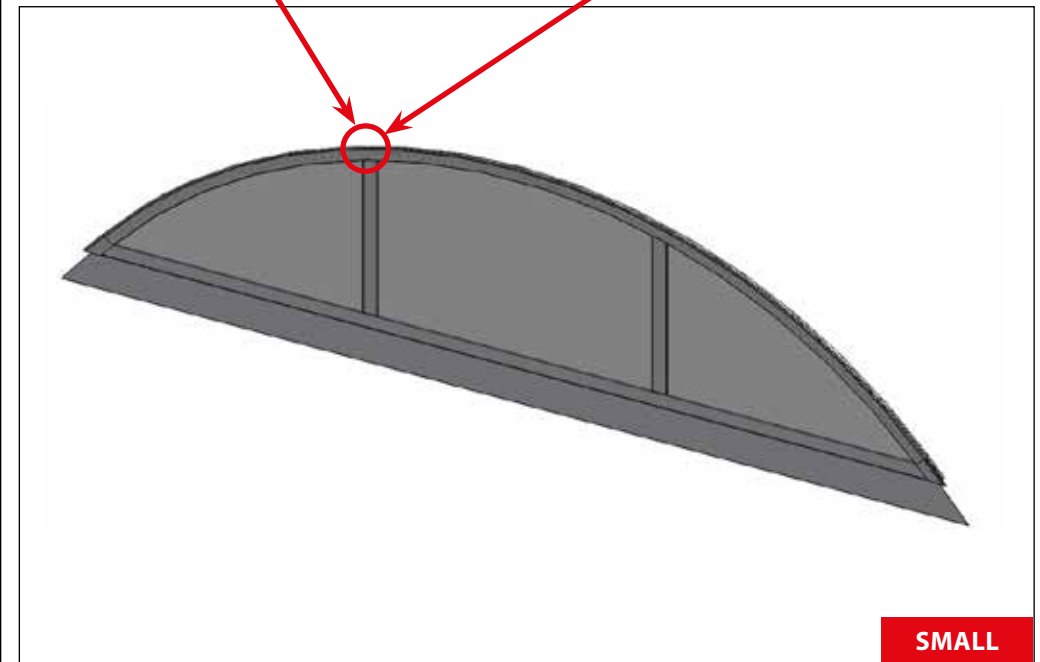
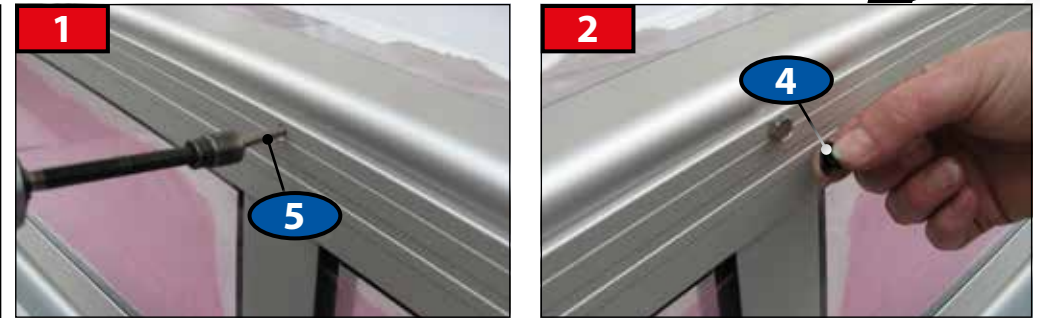
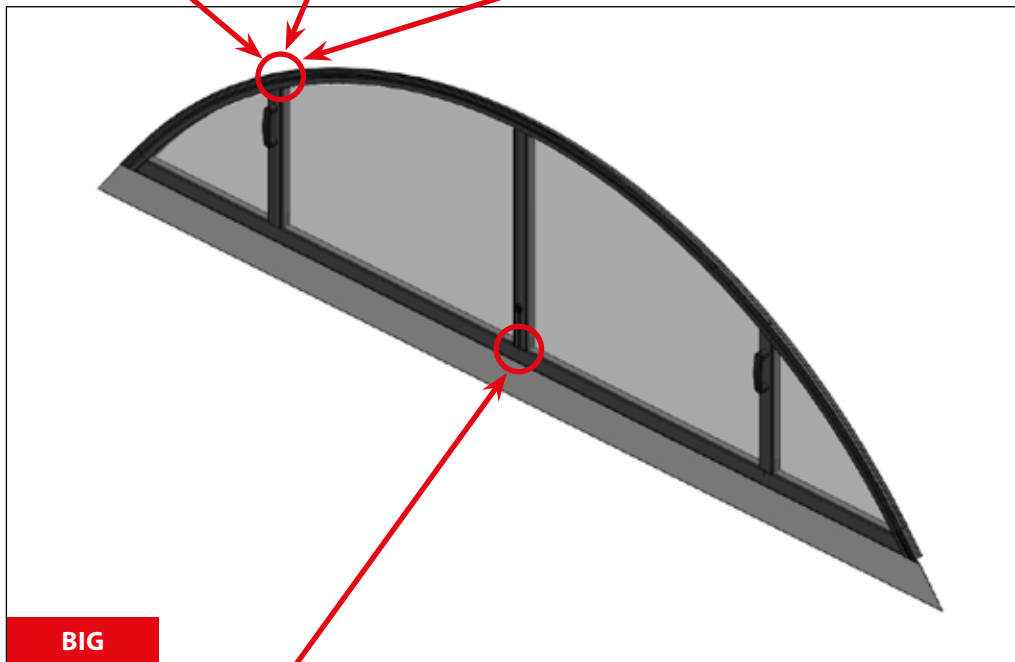

CZ

Dodavatel si vyhrazuje právo na změny a úpravy technických parametrů uváděných v tomto katalogu s ohledem na technický vývoj a zdokonalení výrobků a balení. Dodavatel si vyhrazuje právo na tiskové chyby a chyby v sazbě. Před montáží si pozorně přečtěte návod. Návod si uchovejte pro pozdější použití.

DE

Der Lieferant behält sich das Recht auf Änderungen und Anpassungen der technischen Parameter, die in diesem Katalog aufgeführt sind, mit Rücksicht auf die technische Entwicklung und Verbesserung der Produkte und Verpackung vor. Der Lieferant behält sich das Recht auf Druckfehler und Fehler im Satz vor. Vor der Montage lesen Sie bitte die Anleitung sorgfältig durch. Bewahren Sie die Anleitung für spätere Verwendung auf.

EN

The supplier reserves the right for modifications and adaptations of the technical parameters stated in this catalogue, considering the technical development and upgrade of the products and packaging. The supplier reserves the right for print errors and typographical errors. Please read the manual carefully before you will start the installation. Keep the manual for later use.

ES

El proveedor se reserva el derecho de hacer cambios y modificaciones técnicas de los parámetros que figuran en este catálogo, con respecto al desarrollo técnico mejorando los productos y embalajes. El proveedor se reserva también el derecho a errores de impresión y composición. Antes de empezar la instalación, lea atentamente las instrucciones. Guarde las instrucciones para su uso posterior.

FR

Le fabricant se réserve le droit de modifier les paramètres techniques cités dans ce manuel en considération du développement technique et de l'amélioration des produits et de leur emballage. Le fabricant se réserve le droit des fautes d'impression et de composition. À lire attentivement et à conserver pour une consultation ultérieure.

HU

Gyártó fenntartja jogát a katalógusban feltüntetett műszaki paraméterek változtatására a termékek és csomagolás technikai fejlesztése és tökéletesítése szerint. Szállító: a szállító fenntartja jogát a nyomtatási és szedési hibákra.

IT

Il fornitore si riserva il diritto di effettuare modifiche e correzioni ai parametri tecnici riportati nel presente catalogo per migliorare e perfezionare dal punto di vista tecnico i prodotti e gli imballaggi. Il fornitore non esclude inoltre l'eventuale presenza di errori di stampa e di impaginazione. Prima dell'installazione, leggere attentamente le istruzioni. Tenere l'istruzione per un uso successivo.

PL

Dostawca zastrzega sobie prawo do zmian oraz dostosowania parametrów technicznych podanych w niniejszym katalogu z uwzględnieniem rozwoju technicznego i udoskonalania produktów oraz opakowań. Dostawca zastrzega sobie prawo do błędów druku oraz typograficznych.

PT

O provedor reserva-se o direito a efectuar alterações e adaptações de parâmetros técnicos mencionados neste catálogo, tendo em consideração o avanço técnico e melhorias de produtos e embalagens. O provedor reserva-se o direito a cometer erros de impressora e de edição.

RO

Furnizorul își rezervă dreptul de a modifica și schimba parametrii tehnici menționați în acest catalog cu privire la evoluția tehnică și perfecționarea produselor și a ambalării. Furnizorul își rezervă dreptul la greșelile de tipar și greșelile privind tarifele.

RU

Поставщик оставляет за собой право на изменение и исправление технических параметров продукции указанной в этом каталоге, с учетом технического развития, а усовершенствования изделий и его упаковки. Поставщик оставляет за собой право на опечатку в тексте и в ценах. Перед установкой и эксплуатацией изделия внимательно ознакомьтесь с настоящим руководством. Сохраните данное руководство для дальнейшего использования.